

TechNotes V1.5

Extended Lifecycle Mainboard Series

D3402-B

D3417-B

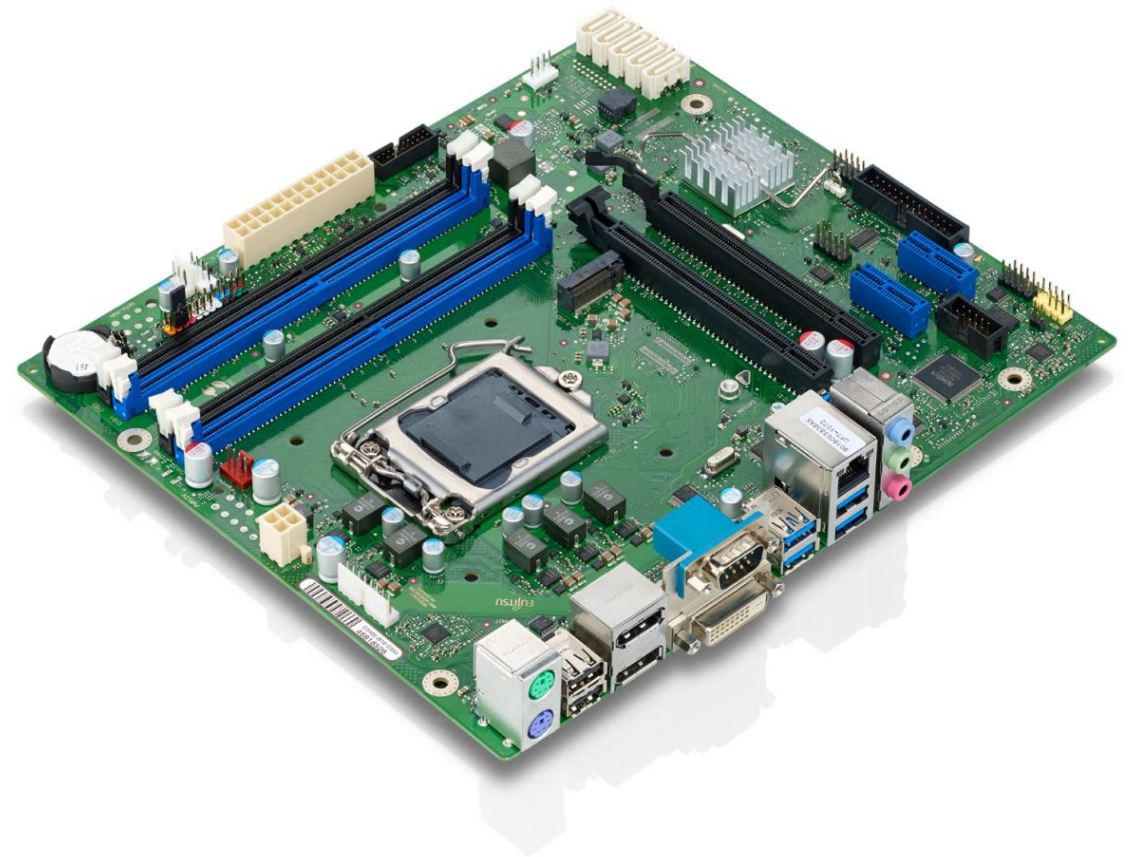

Content

1	Safety Instructions	5
2	Feature Overview	6
2.1	Summary: Feature overview D3402-B & D3417-B [Updated]	6
2.2	Basic Layout D3402-B [Updated]	8
2.3	Basic Layout D3417-B [Updated]	9
2.4	Block Diagramm D3402-B & D3417-B	10
2.5	External Connectors D3402-B / D3417-B	11
2.6	Onboard components D3402-B	12
2.7	Onboard components D3417-B	13
2.8	Mechanical Note / Reduced PCB Size	14
2.9	I/O-Shield	16
3	Interfaces & Connectors	17
3.1	Frontpanel Connector	17
3.2	Internal Serial (COM) Port Connector	18
3.3	External Serial (COM) Port Connector	18
3.4	Internal Parallel Port Connector [Updated]	19
3.5	Internal USB2.0 Connector (2 Ports)	19
3.6	Internal USB3.0 Pin Connector (2 Ports)	20
3.7	Internal USB3.0 Stick Socket	20
3.8	External USB3.0 Connector	21
3.9	PS/2 Keyboard Port	22
3.10	PS/2 Mouse Port	22
3.11	LAN Connector	23
3.12	DVI-D Connector	23
3.13	DisplayPort V1.2 Connector	24
3.14	Serial ATA Connectors	24
3.15	M.2 (Key M) – M2242 & M2260 [Updated]	25
3.16	M.2 Assembly Notes	26
3.17	Fan Connectors	27

3.18	Power Supply Fan Connector	27
3.19	Rear Audio / Frontpanel Audio Connector	28
3.20	Power Supply Connector (Multirail)	30
3.21	Additional Power Supply Connector (12V for Processor)	30
3.22	Chassis Intrusion	31
4	System Monitoring	32
4.1	D3402-B & D3417-B: Temperature Sensors and Fan Connectors	33
4.2	SystemGuard	34
4.3	SystemGuard - Details	35
4.4	SilentFanConfig-Manager – Customize System Monitoring Settings (Optional)	36
4.5	Components for continuous 24/7 operation @ +50°C	37
4.6	Capacitor Endurance Time Comparison	38
4.7	Temperature Reference Points D3402-B & D3417-B	39
4.8	BMC – BIOS Default Settings D3402-B & D3417-B	40
5	Power Supply	41
5.1	ATX Power Supply	41
5.2	Typical Power Consumption	42
6	USB Implementation	43
6.1	USB Ports & USB Power Fuses	43
7	Display Options	45
7.1	Summary: Video Output Options D3402-B & D3417-B	45
8	Operating System Support	47
8.1	Support for Windows 7 / Windows 8.1 / Windows 10 [Updated]	48
8.2	Linux Support	49
9	Mainboard Tools	50
Common Mainboard Tools		50
9.1	BIOS Boot Logo Tool (This tool is only provided to qualified system integrators)	50
9.2	EditCMOS (This tool is only provided to qualified system integrators)	50
9.3	OEMIDENT (This tool is only provided to qualified system integrators)	50
9.4	SystemGuard	51
Industrial Tools		52
9.5	SilentFanConfig-Manager (This tool is only provided to qualified system integrators)	52
9.6	Windows System-Monitoring API (BMC-API - This tool is only provided to qualified system integrators)	52
9.7	Linux System-Monitoring Driver (“LM-Sensors”)	52
10	Known Issues & Important Notes	53



10.1	USB 2.0 – USB 3.0 / MS Windows 7	53
10.2	TPM2.0 / MS Windows	53
10.3	Parallel Port – Intel Limitation	53
11	Miscellaneous	54
11.1	Battery Lifetime	54
11.2	RealTime Clock (RTC) Accuracy	55
11.3	System Watchdog (WD)	56
11.4	BIOS Update / BIOS Recovery	59
11.5	BIOS integrated HW Diagnostic Tool	61
11.6	BIOS integrated Erase Disk Tool (optional)	61

Revision History:

V1.0	First Version	11/2015
V1.1 / V1.2	Some details added	12/2015
V1.3	M.2 added, clarifications for optional Tools, updated Win7 USB information, added Linux information	03/2016
V1.4	Some details added	06/2016
V1.4a	PCIe Slots adjusted	07/2016
V1.4b	Rear USB Ports adjusted – Page 44	09/2016
V1.5	B2 Variant Kabylake update	04/2017

1 Safety Instructions

Do not connect or disconnect any cables or modules to or from any onboard connectors (except for the rear I/O connectors) until the mainboard is completely powered down.

Any damage caused to the mainboard by misuse of the onboard connectors is excluded from the standard warranty. Fujitsu Technology Solutions cannot be held liable for any damage that results from incorrect use of any onboard connectors.

The system integrator is fully responsible for the usage of appropriate connectors and cables in order to fulfill the technical requirements (electrical contact, durability, power/current levels, signal integrity etc.)

2 Feature Overview

2.1 Summary: Feature overview D3402-B & D3417-B [Updated]

Feature	D3402-B1	D3402-B2	D3417-B1	D3417-B2	Notes
Chipset (PCH)	Q170	Q170	C236	C236	incl. heatsink
Memory Sockets / max. RAM / ECC Support ¹⁾	4 / 64GB DDR4-2133 Non-ECC	4 / 64GB DDR4-2400 Non-ECC	4 / 64GB DDR4-2133 ECC / Non-ECC	4 / 64GB DDR4-2400 ECC / Non-ECC	Appropriate processor required for ECC
Future Intel® Xeon® E3-1200 processor series (max. 80W TDP)	--	--	--	X	
Intel® Xeon® E3-1200 V5 processor series (max. 80W TDP)	--	--	X	X	
Intel® Core™ i7 / i5 / i3 – (7th gen.) processor series (max. 65W TDP)	--	X	--	X	K-Series not supported!
Intel® Core™ i7 / i5 / i3 – (6th gen.) processor series (max. 65W TDP)	X	X	X	X	K-Series not supported!
Intel® Pentium® / Celeron® processor series (max. 65W TDP)	X	X	X	X	
TPM V1.2 / TPM V2.0	-- / Infineon	-- / Infineon	-- / Infineon	-- / Infineon	
mSATA Socket & Mini-PCIe Socket (shared) / 8 Bit GPIO	-- / --	-- / --	-- / --	-- / --	
M.2 Socket	X (PCIe x4 & SATA based M.2 modules supported)	X (PCIe x4 & SATA based M.2 modules supported)	X (PCIe x4 based M.2 modules supported)	X (PCIe x4 based M.2 modules supported)	Mechanical support for 60mm and 80mm modules; Key M
USB2.0 Ports internal / external	4 / 2	4 / 2	4 / 2	4 / 2	
USB3.0 Ports internal / external / USB 3.0 Stick Socket onboard	2 / 4 / 1	2 / 4 / 1	2 / 4 / 1	2 / 4 / 1	
Fan 1 / 2 / 3 / 4	X / X / X / --	X / X / X / --	X / X / X / --	X / X / X / --	All fans 4-pin PWM; no support for 3-pin fan regulation
PSU Fan Control	X	X	X	X	
SATA3 / RAID Support (0/1/5/10)	5 / X	5 / X	6 / X	6 / X	

Feature Overview

Summary: Feature overview D3402-B & D3417-B [Updated]

Feature	D3402-B1	D3402-B2	D3417-B1	D3417-B2	Notes
S/P-DIF / Intrusion / SCSI LED	-- / X / --	-- / X / --	-- / X / --	-- / X / --	
Slot #1: PCIe x1	1 lane, Gen3(open)	1 lane, Gen3(open)	1 lane, Gen3(open)	1 lane, Gen3(open)	
Slot #2: PCIe x1	1 lane, Gen3(open)	1 lane, Gen3(open)	1 lane, Gen3(open)	1 lane, Gen3(open)	
Slot #3: PCIe x16 (PEG Slot)	Gen3	Gen3	Gen3	Gen3	
Slot #4: PCIe x16	4 lanes, Gen3	4 lanes, Gen3	4 lanes, Gen3	4 lanes, Gen3	
COM-Port external / COM-Port internal / Parallel Port internal	1 / 1 / 1	1 / 1 / 1	1 / 1 / 1	1 / 1 / 1	
DVI-D / DisplayPort 1 / DisplayPort 2 / LVDS / Embedded DisplayPort	X / X / X / -- / --	X / X / X / -- / --	X / X / X / -- / --	X / X / X / -- / --	
Intel iAMT 11 - vPro 2015 Manageability	X	X	X	X	Appropriate processor required for full iAMT functionality; otherwise Standard Manageability only supported.
BIOS-POST / BIOS-Boot / OS - HW Watchdog onboard	X / X / X	X / X / X	X / X / X	X / X / X	
Approved for 24/7 operation @ 50°C / full load	X / --	X / --	X / --	X / --	
UL/CSA 60950-1 certification	X	X	X	X	
FCC/B approval	X	X	X	X	
EraseDisk (BIOS Feature) included	optional	optional	optional	optional	

Feature Overview

2.2 Basic Layout D3402-B **[Updated]**

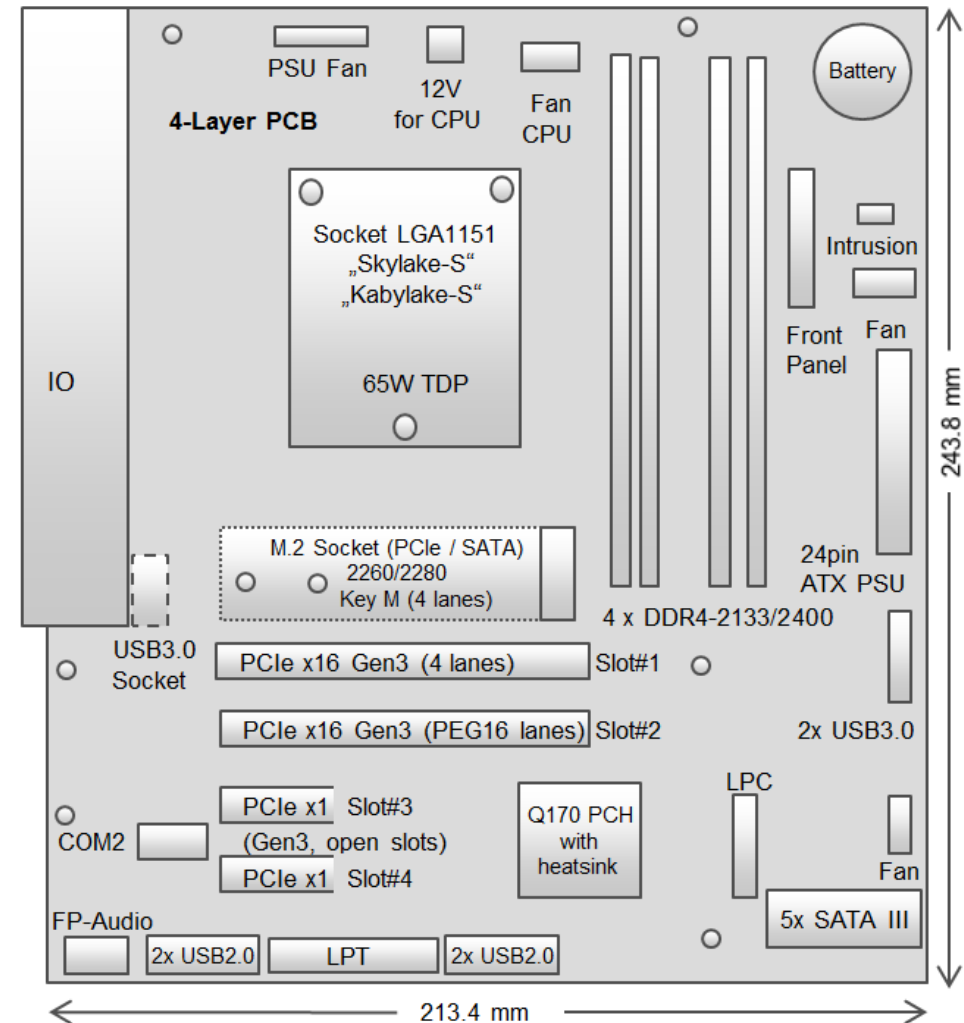

Feature Overview

2.3 Basic Layout D3417-B **[Updated]**

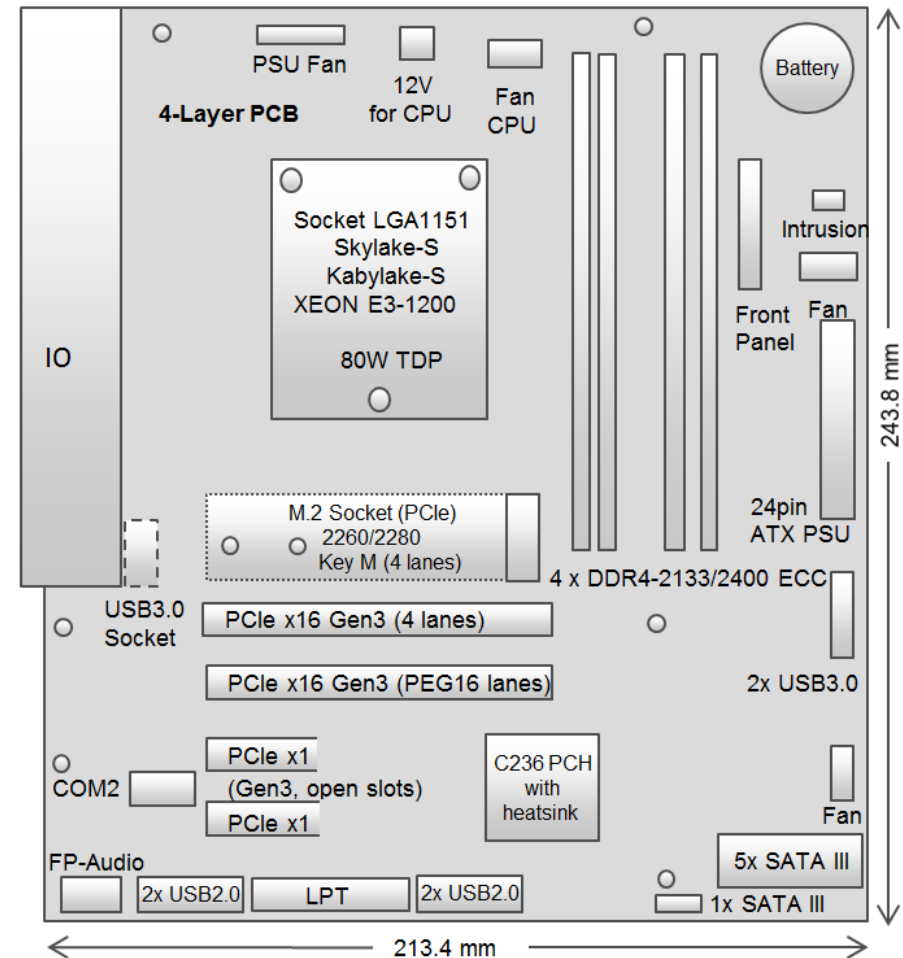

Feature Overview

2.4 Block Diagramm D3402-B & D3417-B

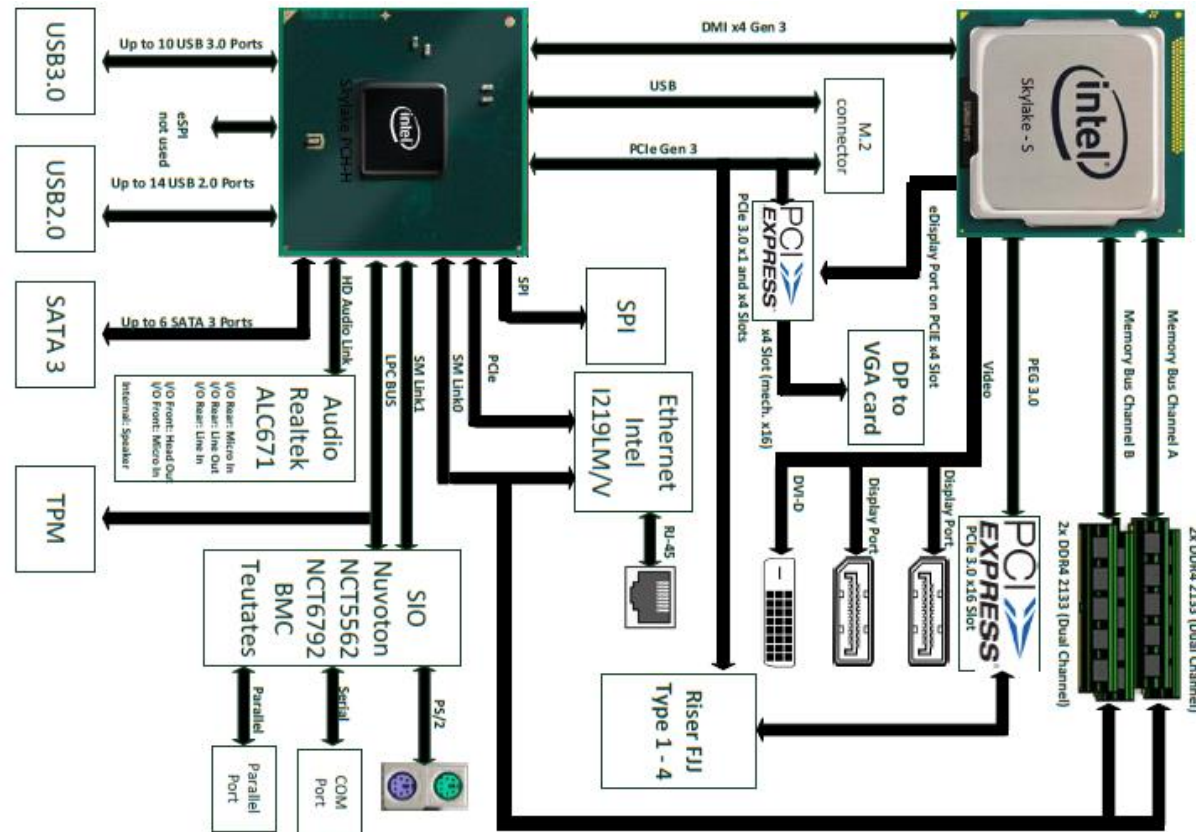

Feature Overview

2.5 External Connectors D3402-B / D3417-B

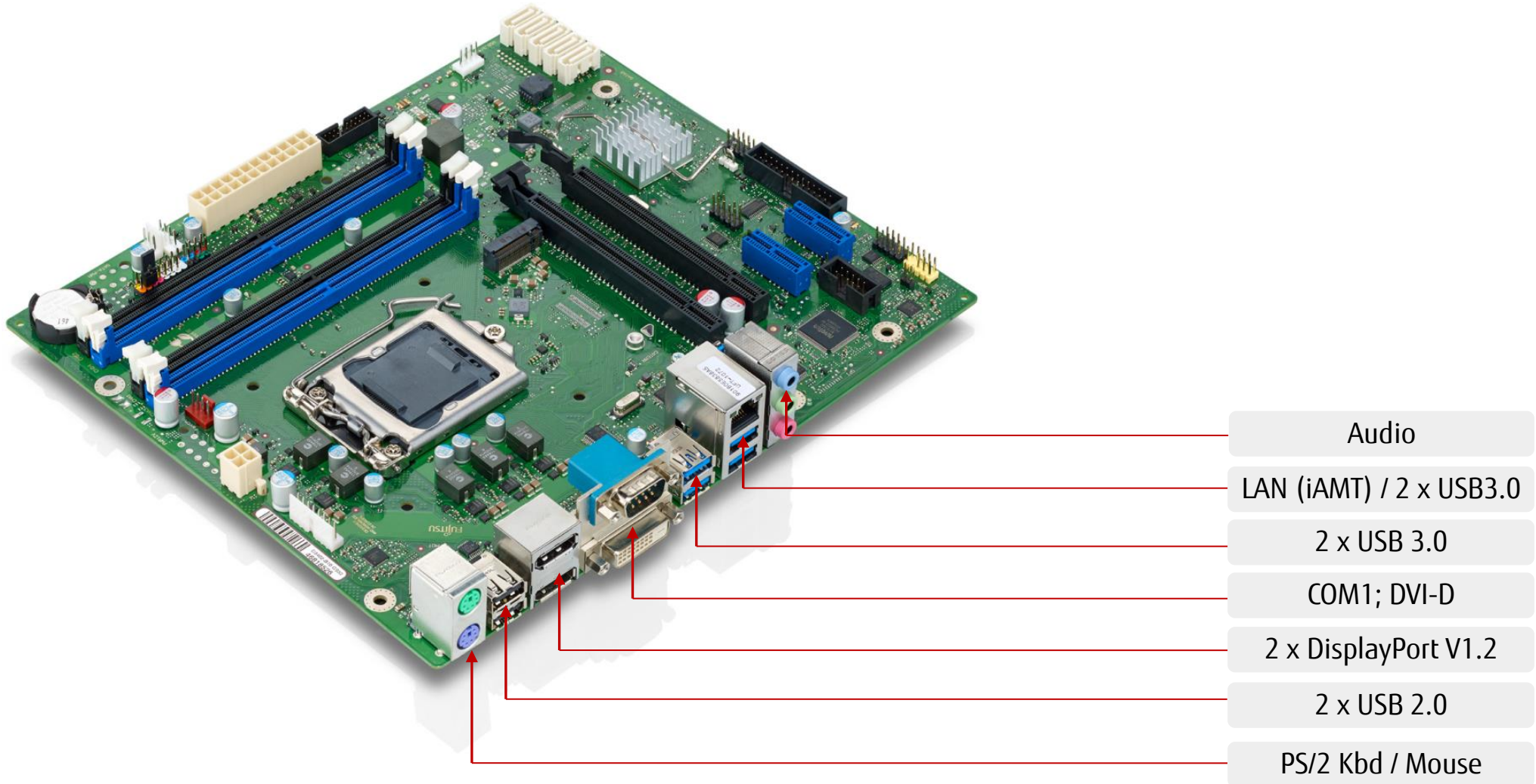

- Audio
- LAN (iAMT) / 2 x USB3.0
- 2 x USB 3.0
- COM1; DVI-D
- 2 x DisplayPort V1.2
- 2 x USB 2.0
- PS/2 Kbd / Mouse

Feature Overview

2.6 Onboard components D3402-B

4 Layer PCB

Fan OEM (4 pin PWM)

Intrusion

Frontpanel

Fan CPU (4 pin PWM)

M.2 Socket (PCIe or SATA)

12V Supply (Processor)

CPU LGA1151 max. 65W

PSU Fan Control

USB 3.0 Socket (Stick)

PCIe x16 (4 lanes, Gen3)

24 pin ATX PSU

2x USB 3.0 (Frontpanel)

Fan SYS (4 pin PWM)

5 x SATA-III

COM2 Port

2 x USB 2.0 (Frontpanel)

Parallel Port

2 x USB 2.0 (Internal)

Frontpanel Audio

PCIe x1 (1 lane, Gen3, open slot)

PCIe x1 (1 lane, Gen3, open slot)

PCIe x16 (16 lanes, Gen3)

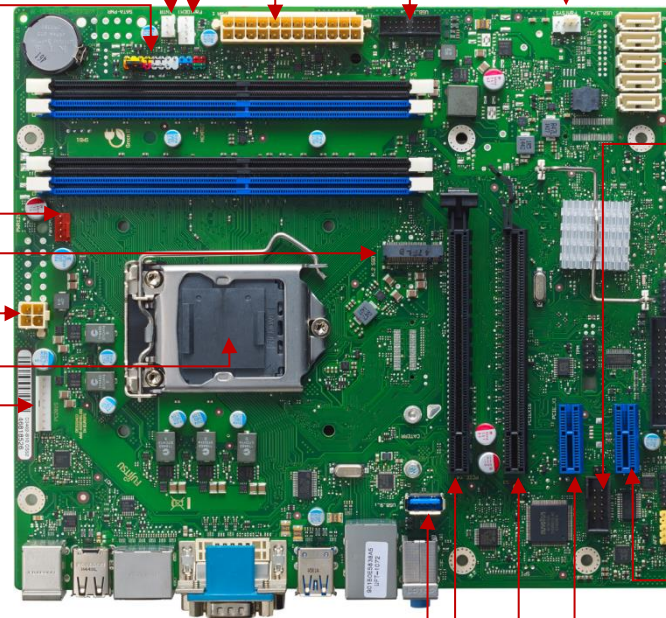

Feature Overview

2.7 Onboard components D3417-B

4 Layer PCB

Fan OEM (4 pin PWM)

Intrusion

Frontpanel

Fan CPU (4 pin PWM)

M.2 Socket (PCIe only)

12V Supply (Processor)

CPU LGA1151 max. 80W

PSU Fan Control

USB 3.0 Socket (Stick)

PCIe x16 (4 lanes, Gen3)

24 pin ATX PSU

2x USB 3.0 (Frontpanel)

Fan SYS (4 pin PWM)

6 x SATA-III

COM2 Port

2 x USB 2.0 (Frontpanel)

Parallel Port

2 x USB 2.0 (Internal)

Frontpanel Audio

PCIe x1 (1 lane, Gen3, open slot)

PCIe x1 (1 lane, Gen3, open slot)

PCIe x16 (16 lanes, Gen3)

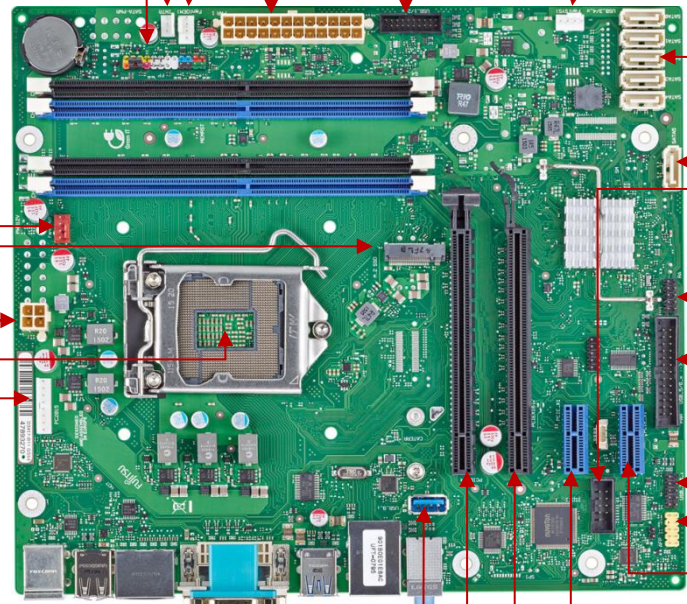

Feature Overview

2.8 Mechanical Note / Reduced PCB Size

The PCB (Printed Circuit Board) of D3402 / D3417 has been reduced compared to a standard μ ATX PCB (see picture below). Accordingly the two (red) mounting holes of a μ ATX PCB are not available on D34xx. In order to improve the mechanical stability (e.g. for installing the ATX power connector), there is an additional mounting hole (4mm diameter; marked "green" in the picture below). This mounting hole can be used for an optional nylon spacer to retain the mainboard.

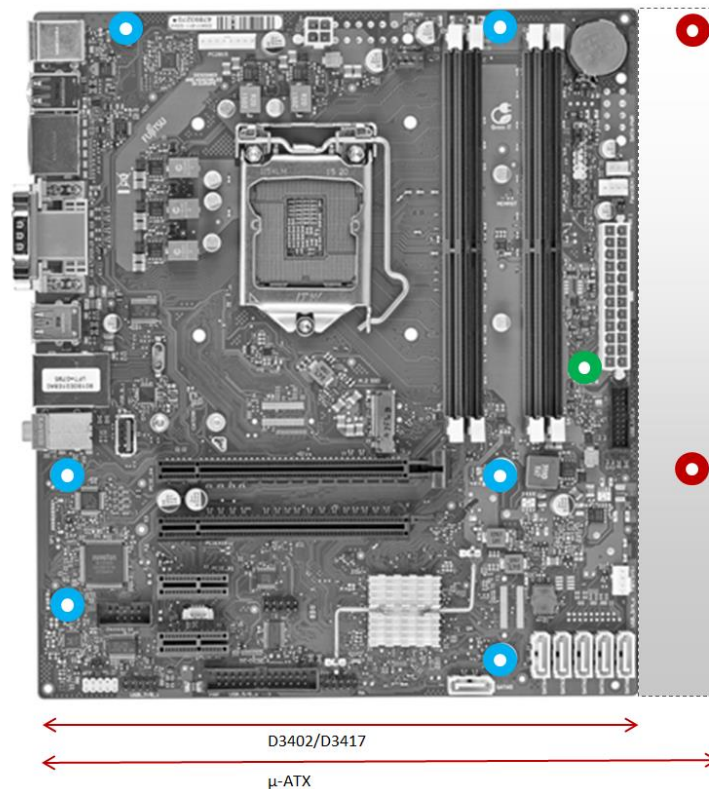

Feature Overview

Mechanical Note / Reduced PCB Size

Recommended spacer:
 Richco CBSB-4-01A2-RT / CBSB-4-19A2-RT (dimension "A" = 6.4mm)

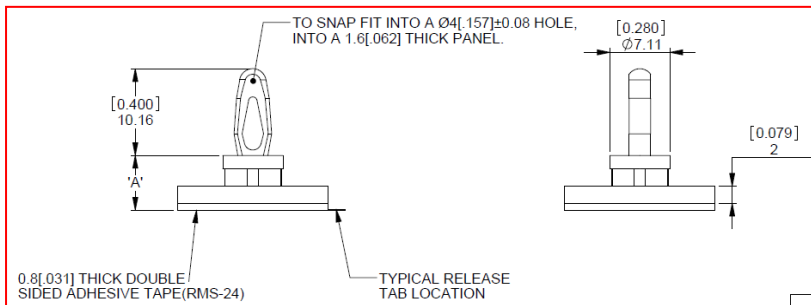

Note: As the spacer height depends on the customer chassis, there is no spacer included in the mainboard delivery!

Feature Overview

2.9 I/O-Shield

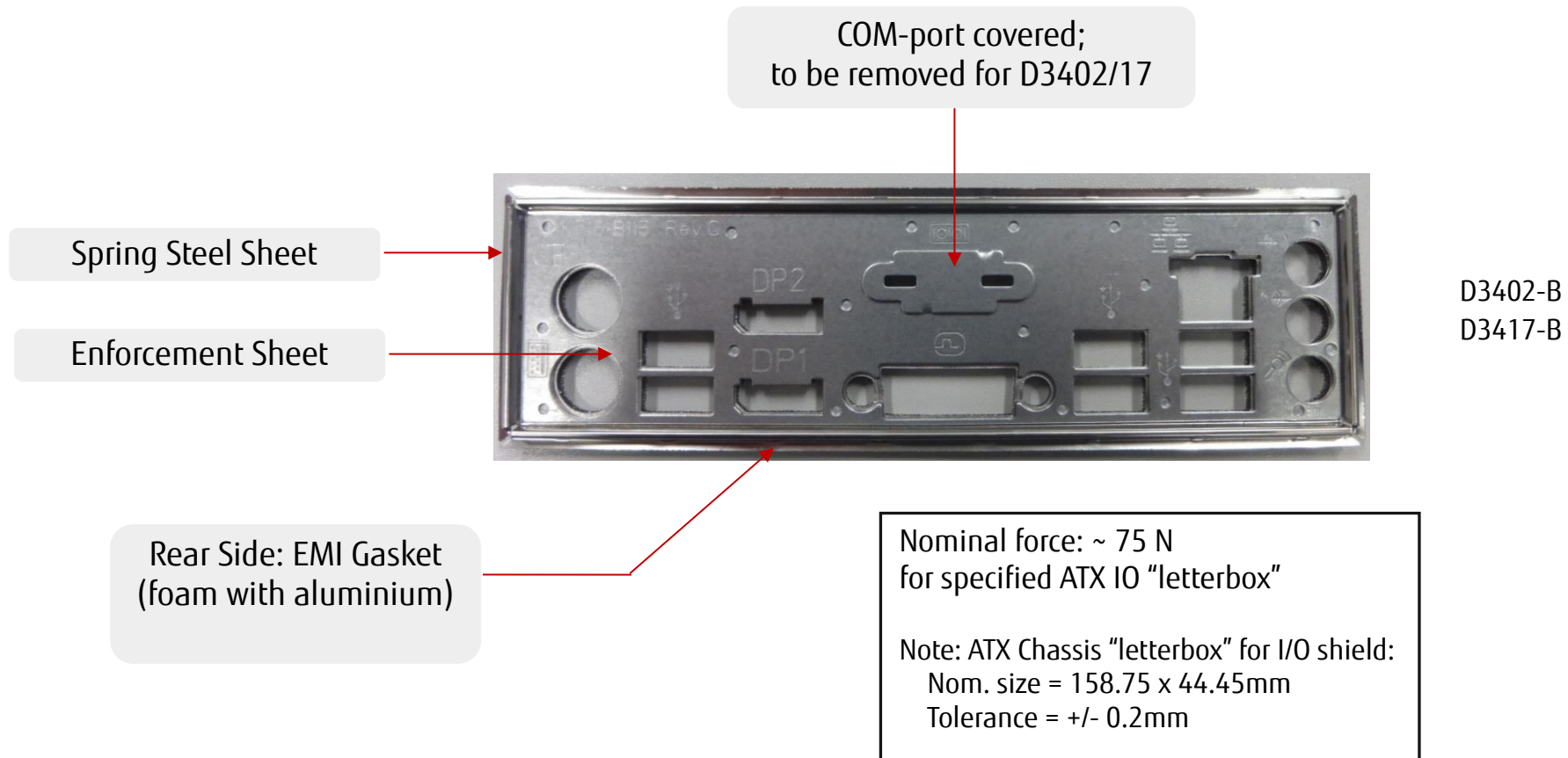

3 Interfaces & Connectors

3.1 Frontpanel Connector

Pin	Signal
1	HD-LED +
3	HD-LED -
5	GND
7	RST_L
9	reserved
11	reserved
13	reserved
15	reserved
17	Speaker +
19	GND
21	Key
23	Speaker -

Pin	Signal
2	Power LED +
4	Power LED -
6	Power Button
8	GND
10	Key
12	GND
14	reserved
16	reserved
18	BIOS test mode (reserved)
20	reserved
22	reserved
24	Recover BIOS

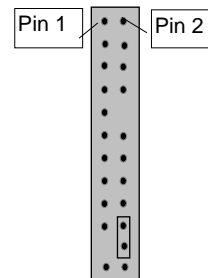

Power LED:

Anode: Pin 2 – current source 10mA, up to 4V

Cathode: Pin 4 (suitable for various LED colors)

HDD LED:

Anode: Pin 1 – current source 5mA, up to 4V

Cathode: Pin 3 (suitable for various LED colors)

Internal Speaker Output:

Differential audio signal; mono, max. 2W RMS / min. 40hm

Note: System Beeps are audible via the internal speaker output only, even if a device is connected to the external audio ports (rear/front) .

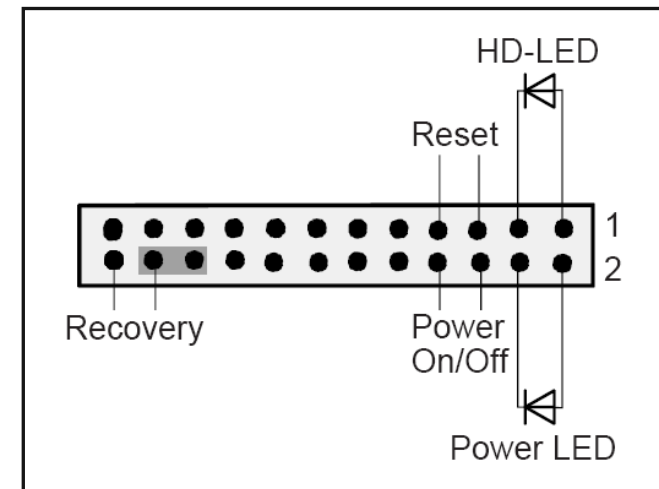

Interfaces & Connectors

3.2 Internal Serial (COM) Port Connector

Pin	Signal
1	DCD
3	SIN
5	SOUT
7	DTR
9	GND

Pin	Signal
2	DSR
4	RTS
6	CTS
8	RI
10	Key

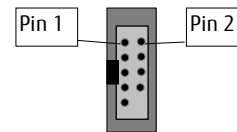

Note: D3402/17: The internal COM-Port is COM2

3.3 External Serial (COM) Port Connector

Pin	Signal
1	DCD
2	SIN
3	SOUT
4	DTR
5	GND

Pin	Signal
6	DSR
7	RTS
8	CTS
9	RI

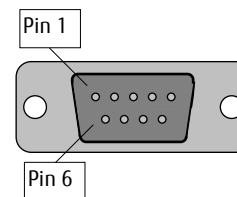

Interfaces & Connectors

3.4 Internal Parallel Port Connector **[Updated]**

Pin	Signal
1	Strobe
3	Data0
5	Data1
7	Data2
9	Data3
11	Data4
13	Data5
15	Data6
17	Data7
19	ACK
21	Busy
23	Empty
25	Select

Pin	Signal
2	AutoFD
4	Error
6	Init
8	Sel_L
10	GND
12	GND
14	GND
16	GND
18	GND
20	GND
22	GND
24	GND
26	Reserved

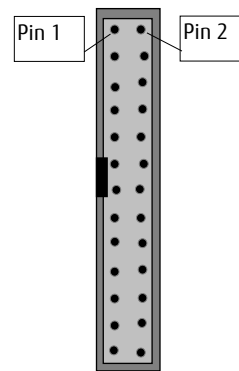

optional parallel port cable with ATX bracket

3.5 Internal USB2.0 Connector (2 Ports)

Pin	Signal
1	+5V (fuse protected)
3	USB2 Data negative (Port 1)
5	USB2 Data positive (Port 1)
7	GND
9	Key

Pin	Signal
2	+5V (fuse protected)
4	USB2 Data negative (Port 2)
6	USB2 Data positive (Port 2)
8	GND
10	Not connected

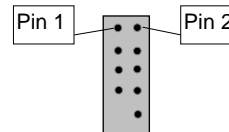

Interfaces & Connectors

3.6 Internal USB3.0 Pin Connector (2 Ports)

Pin	Signal
19	+5V (fused protected)
18	USB3 RX negative (Port2)
17	USB3 RX positiv (Port2)
16	GND
15	USB3 TX negative (Port2)
14	USB3 TX positive (Port2)
13	GND
12	USB2 Data negative (Port2)
11	USB2 Data positive (Port2)

Pin	Signal
1	+5V (fuse protected)
2	USB3 RX negative (Port1)
3	USB3 RX positive (Port1)
4	GND
5	USB3 TX negative (Port1)
6	USB3 TX positive (Port1)
7	GND
8	USB2 Data negative (Port1)
9	USB2 Data positive (Port1)
10	NC

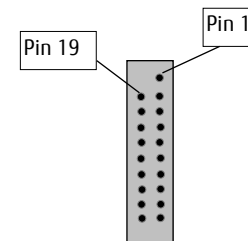

Note:

All USB3 connectors provide separate signal lines for USB3.0 and USB2.0!

All "fused" ports provide max. 500mA (USB2.0) resp. . 900mA (USB3.0) for each port

The internal USB 3.0 stick socket must NOT be used for externally accessible connectors because the power line is not fuse-protected!

3.7 Internal USB3.0 Stick Socket

Pin	Signal
1	+5V (fuse protected)
2	USB2 Data negative
3	USB2 Data positive
4	GND
5	USB3 RX negative
6	USB3 RX positiv
7	GND
8	USB3 TX negative
9	USB3 TX positive

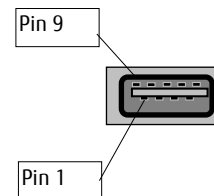

Interfaces & Connectors

3.8 External USB3.0 Connector

Pin	Signal
1	+5V (fused protected)
2	USB2 Data negative
3	USB2 Data positive
4	GND
5	USB3 RX negative
6	USB3 RX positiv
7	GND
8	USB3 TX negative
9	USB3 TX positive

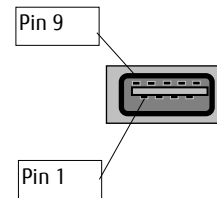

Interfaces & Connectors

3.9 PS/2 Keyboard Port

Pin	Signal
1	KBD Data
2	Not connected
3	GND
4	+5V (fuse protected)
5	KBD CLK
6	Keyboard_On (low asserted pulse)

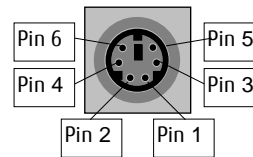

3.10 PS/2 Mouse Port

Pin	Signal
1	MOUSE Data
2	Not connected
3	GND
4	+5V (fuse protected)
5	MOUSE CLK
6	Not connected

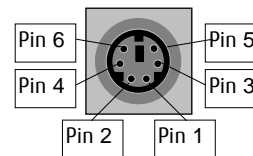

Interfaces & Connectors

3.11 LAN Connector

Pin	Signal with 10/100/1000	Signal with 10/100
1	MX1 +	TX +
2	MX1 -	TX -
3	MX2 +	RX +
4	MX3 +	TERMPANE
5	MX3 -	TERMPANE
6	MX2 -	RX -
7	MX4 +	TERMPANE
8	MX4 -	TERMPANE

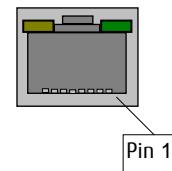

3.12 DVI-D Connector

Pin	Signal
1	Data2+
2	Data2-
3	GND
4	NC
5	NC
6	DDC_CLK
7	DDC_DAT
8	NC
9	Data1-
10	Data1+
11	GND
12	NC
C5	GND

Pin	Signal
13	NC
14	+5V (fuse protected)
15	GND
16	Hot_Plug_detect
17	Data0-
18	Data0+
19	GND
20	NC
21	NC
22	GND
23	CLK+
24	CLK-

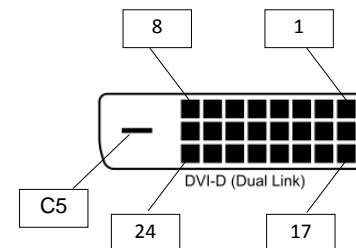

Note: DVI-D (Dual Link) Socket supports Single-Link only!

Interfaces & Connectors

3.13 DisplayPort V1.2 Connector

Pin	Signal
1	Link0+
2	Link0-
3	GND
4	Link2+
5	Link2-
6	GND
7	DVI dongle detect / (GND (N/A))
8	AUX+
9	AUX-
10	GND (Return)

Pin	Signal
11	GND
12	Link1+
13	Link1-
14	GND
15	Link3+
16	Link3-
17	GND / (CEC for HDMI (N/A))
18	GND
19	Hotplug detect
20	+3.3V (fuse protected)

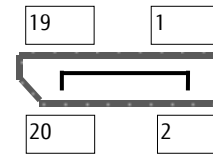

3.14 Serial ATA Connectors

Pin	Signal
1	GND
3	Transmit data negative
5	Receive data negative
7	GND

Pin	Signal
2	Transmit data positive
4	GND
6	Receive data positive



Interfaces & Connectors

3.15 M.2 (Key M) – M2242 & M2260 **[Updated]**

D3402-B: M.2 cards with SATA or PCIe are supported. PCIe is connected with 4lanes.

D3417-B: only M.2 PCIe is supported. PCIe is connected with 4lanes.

Note: M.2 NVME modules with integrated Option ROM are not supported.

→ [See recommended M.2 NVME Modules](#)

Pin	Signal Assignment		Comment
	SATA (D3402 only)	PCIe	
1	GND		
3	GND		
5	RSVD	PCIe RX 3-	
7	RSVD	PCIe RX 3+	
9	GND		
11	RSVD	PCIe TX 3-	
13	RSVD	PCIe TX 3+	
15	GND		
17	RSVD	PCIe RX 2-	
19	RSVD	PCIe RX 2+	
21	GND		
23	RSVD	PCIe TX 2-	
25	RSVD	PCIe TX 2+	
27	GND		
29	RSVD	PCIe RX 1-	
31	RSVD	PCIe RX 1+	
33	GND		
35	RSVD	PCIe TX 1-	
37	RSVD	PCIe TX 1+	
39	GND		
41	SATA RX+	PCIe RX 0-	
43	SATA RX-	PCIe RX 0+	
45	GND		
47	SATA TX-	PCIe TX 0-	
49	SATA TX+	PCIe TX 0+	
51	GND		
53	REFCLK-		
55	REFCLK+		
57	GND		
59			
61	Key		Key M socket
63			
65			
67	NC		
69	MSATA Present #		identify MSATA card
71	GND		
73	GND		
75	GND		

Pin	Signal Assignment		Comment
	SATA (D3402 only)	PCIe	
2	+3.3V		
4	+3.3V		
6	NC		
8	NC		
10	LED SSD	RSVD	
12	+3.3V		
14	+3.3V		
16	+3.3V		
18	+3.3V		
20	NC		
22	NC		
24	NC		
26	NC		
28	NC		
30	NC		
32	NC		
34	NC		
36	NC		
38	Device sleep	RSVD	
40	NC		
42	NC		
44	NC		
46	NC		
48	NC		
50	RSVD	PERST#	
52	NC		
54	NC		
56	RSVD		
58	RSVD		
60			
62	Key		Key M socket
64			
66			
68	NC		
70	+3.3V		
72	+3.3V		
74	+3.3V		

Interfaces & Connectors

3.16 M.2 Assembly Notes

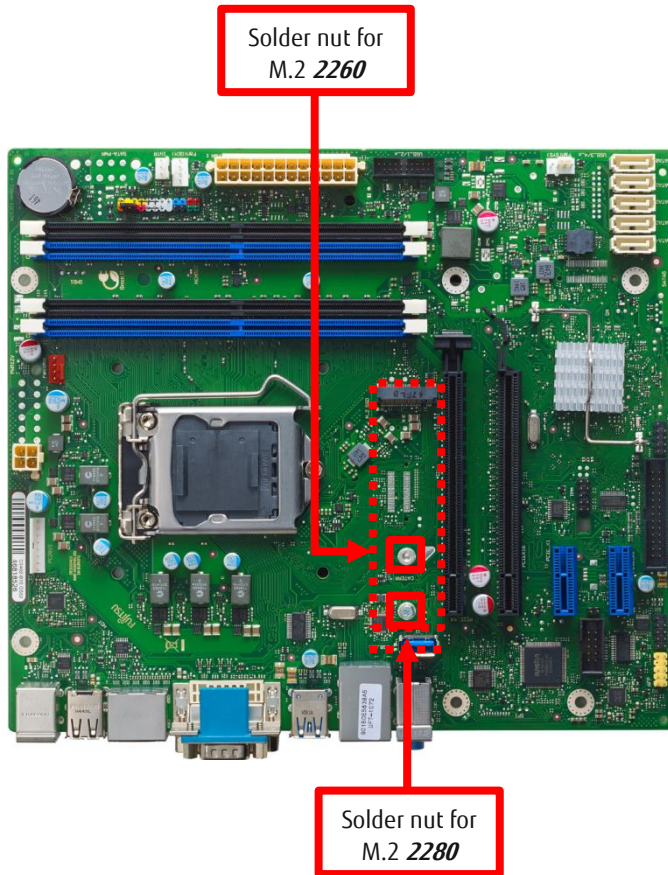

Module Assembly Kit
 (included in mainboard shipment)
 contains 1 metal spacer nut
 and 1 mounting screw
 (M3 x 3.5mm ,bolt head $\varnothing = 4.5\text{mm}$).

**Mandatory torque for mounting
 M3 screw: 0.4Nm +/- 0.05Nm**

**Mandatory torque for mounting
 spacer nut: 0.6Nm +/- 0.05Nm**

Max. torque must never be exceeded,
 otherwise the mainboard (solder
 nuts) may be damaged.

Note: Damaged solder nuts are **not**
 covered by any warranty!

(mounting screw)



(spacer nut)

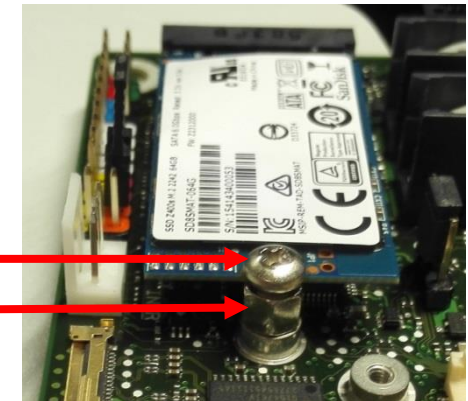

Interfaces & Connectors

3.17 Fan Connectors

Pin	Signal
1	GND
2	12V
3	FAN Sense
4	FAN PWM

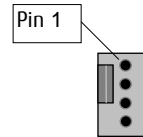

Note:
Fans must never be attached or removed while the system is powered. Mainboard may be damaged!

Fan speed control is supported for 4 pin (PWM) fans.

Fan current: max. 2A continuous / 4A peak

Note: 3 pin fans are supported, but they will operate at full speed resp. 12V supply voltage only!

3.18 Power Supply Fan Connector

Pin	Signal
1	Not connected
2	PS Fan PWM
3	Not connected
4	PS FAN Sense
5	Not connected
6	Not connected
7	Not connected
8	GND

Note: This feature is not supported by standard ATX power supplies!

Interfaces & Connectors

3.19 Rear Audio / Frontpanel Audio Connector

Frontpanel Audio: High Definition Mode

Pin	Signal
1	HDA Port 1 Left
3	HDA Port 1 Right
5	HDA Port 2 Right
7	Jack Sense common
9	HDA Port 2 Left

Pin	Signal
2	Analogue GND
4	FP Presence Detect
6	Jack Sense Port 1
8	Key
10	Jack Sense Port 2

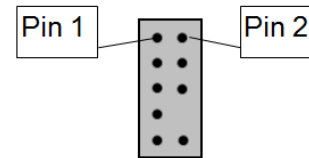

Note: Legacy AC97 mode is NOT supported

Interfaces & Connectors

Rear Audio / Frontpanel Audio Connector

Rear Audio Connectors

Jack	Signal
A	Line input

Jack	Signal
B	Headphone output

Jack	Signal
C	Microphone input

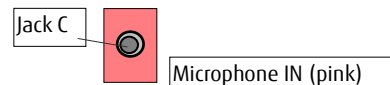
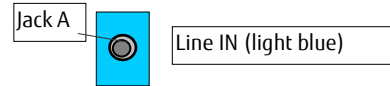

Electrical input characteristics

Line: Stereo max. 1,2V_{rms} (Gain=0dB) input voltage

Microphone: Supports electret microphones with 1,3V_{rms} (Gain=0dB) or 0,13V_{rms} (Gain=20dB)

Electrical output characteristics

Headphone: Stereo max. 1,2 V_{rms} output voltage at 320hm load

System Speaker (via frontpanel connector): Mono, typ. 2W (RMS) at 40hm load

Mute Topology

When an output device (HeadPhone, HifiAmp...) is attached to an output jack, the following mute topology is required:

→ FrontOut mutes RearOut and MonoOut → RearOut mutes MonoOut (frontpanel system speaker)

Remark: System beeps are only audible via the internal (frontpanel) system speaker. System beeps are also audible on the internal speaker if an external device is plugged in.

Interfaces & Connectors

3.20 Power Supply Connector (Multirail)

Pin	Signal
13	+ 3.3V
14	- 12V (not used)
15	GND
16	PS_ON (low asserted)
17	GND
18	GND
19	GND
20	- 5V (not used)
21	+ 5V
22	+ 5V
23	+ 5V
24	GND

Pin	Signal
1	+ 3.3V
2	+ 3.3V
3	GND
4	+ 5V
5	GND
6	+ 5V
7	GND
8	PWR_OK (high asserted)
9	+ 5V Aux
10	+ 12V
11	+ 12V
12	+ 3.3V

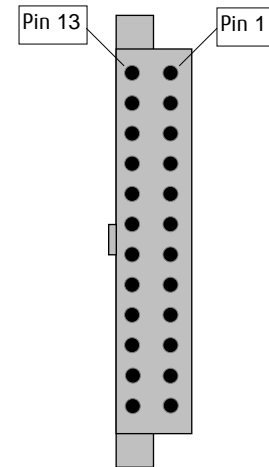

3.21 Additional Power Supply Connector (12V for Processor)

Pin	Signal
3	+ 12V
4	+ 12V

Pin	Signal
1	GND
2	GND

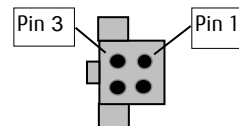

Interfaces & Connectors

3.22 Chassis Intrusion

Pin	Signal
1	GND
2	Case open (low asserted)
3	Intrusion switch present (low asserted)

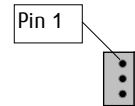

Note:

The intrusion supervision feature needs to be enabled in BIOS Setup first (Menu „Security“ → „Cabinet Monitoring“).
This BIOS option is only available if pin 3 („Intrusion Switch Present“) is connected to GND!

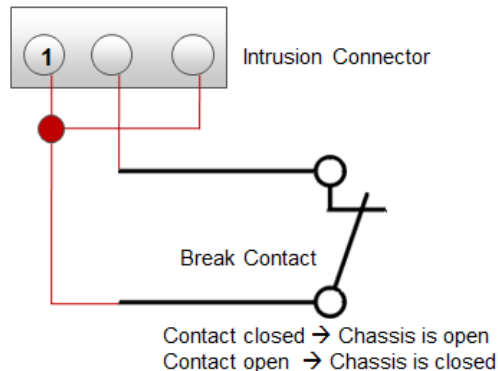

Note:

Chassis intrusion is active even if the system is switched off (S5 state) or disconnected from mains power.
The intrusion event is monitored by the chipset (PCH) and stored in the BIOS event log during the next Boot.
A timestamp (Boot date/time) will be added then.
Note: This timestamp does not represent date/time of the intrusion event!
If a Supervisor Password is enabled in BIOS Setup, the system will stop during BIOS POST if an intrusion event has been detected. In order to continue, the Supervisor Password must be entered to confirm the intrusion event.

The intrusion status can be monitored by using the optional BMC API (Windows, only provided to qualified system integrators):

http://ftp.ts.fujitsu.com/pub/Mainboard-OEM-Sales/Products/Mainboards/Industrial&ExtendedLifetime/D3402-B_D3417-B/

4 System Monitoring

- Temperature Sensors and Fans
- SystemGuard: Fan / Temperature Monitor
- SilentFanConfig-Manager (optional)
- Temperature Reference Points
- BMC – BIOS Default Settings

System Monitoring

4.1 D3402-B & D3417-B: Temperature Sensors and Fan Connectors

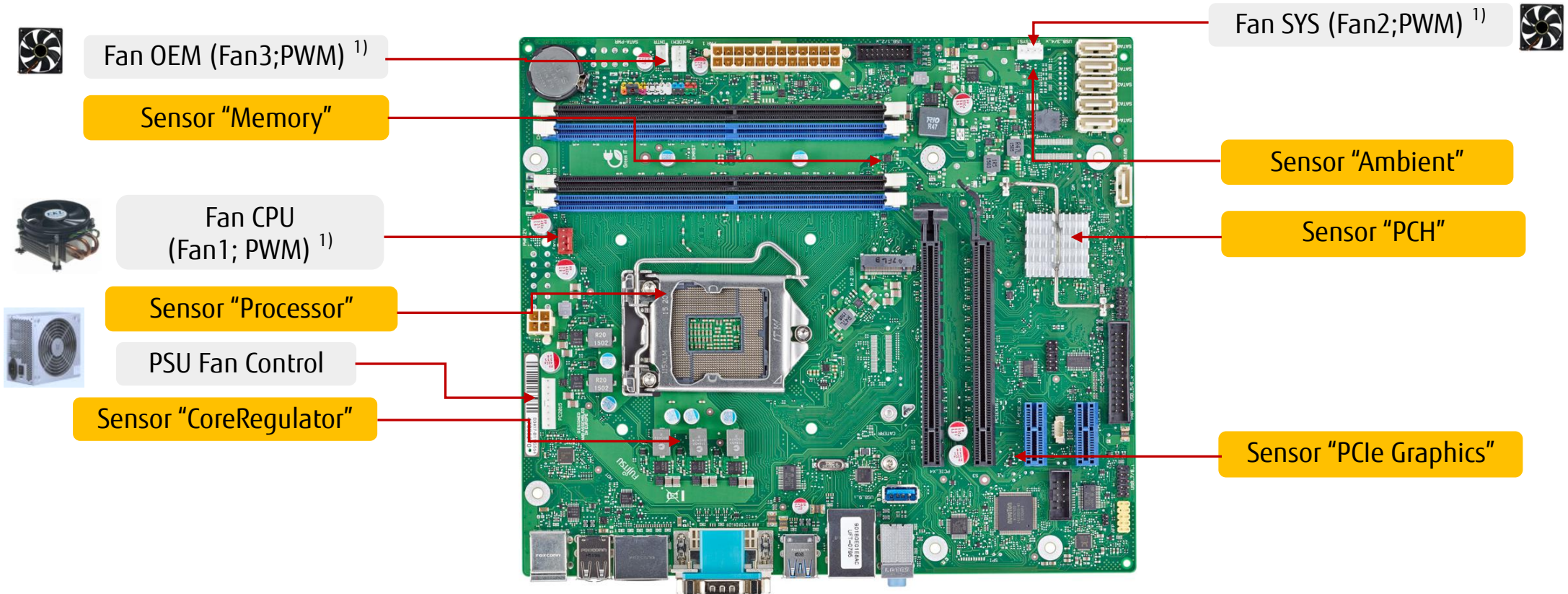

1) 2A continuous / 4A peak current

**Note: Do not attach more than one fan per connector!
Remove or connect fans only when unit is powered off!**

System Monitoring

4.2 SystemGuard

System Monitoring Tool:

- Visualizes processor and sensor temperature data
- Displays current speed for all attached fans
- User can configure fan ageing check (menu "Special")
- User can configure system watchdog (menu "Special")

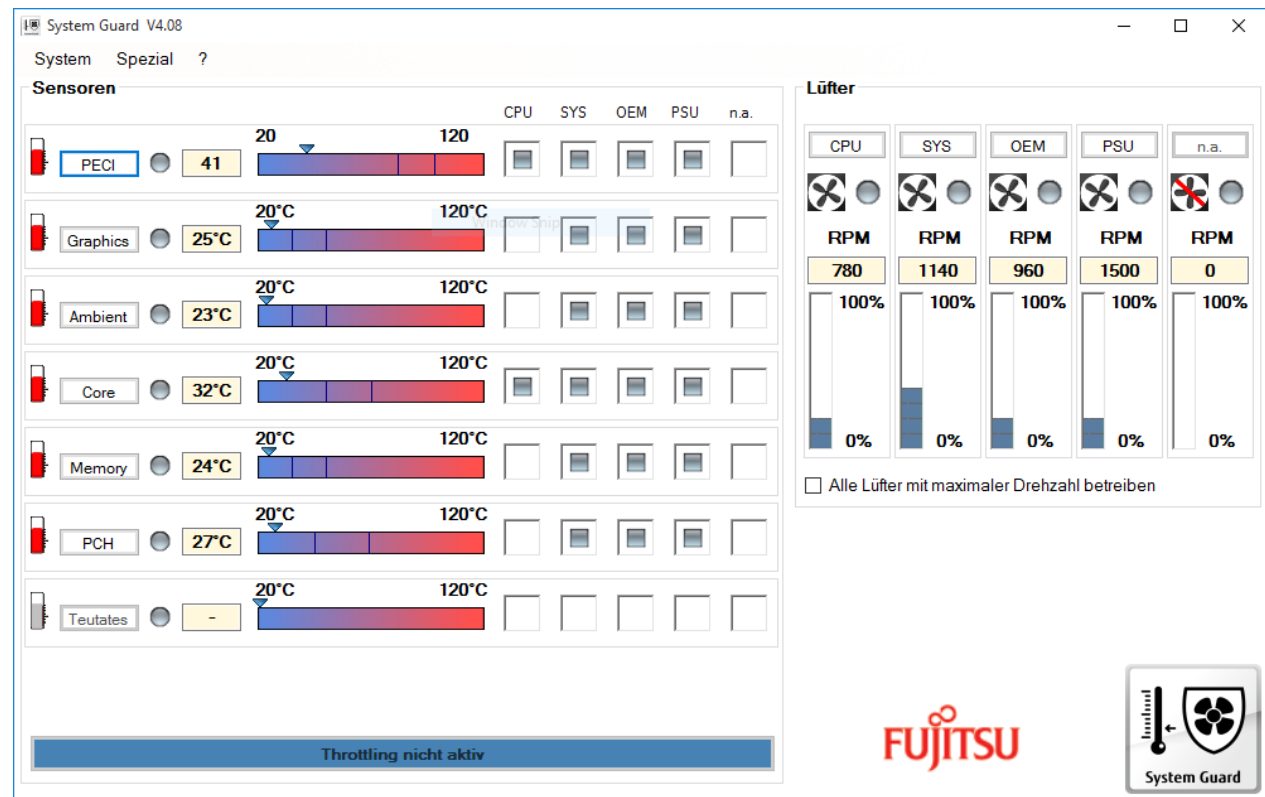

System Monitoring

4.3 SystemGuard - Details

Temperature Sensors

Processor Sensor ¹⁾

Sensor PCIe Graphics

Ambient Temperature

Core Voltage Regulator Sensor

Memory Sensor

PCH Sensor

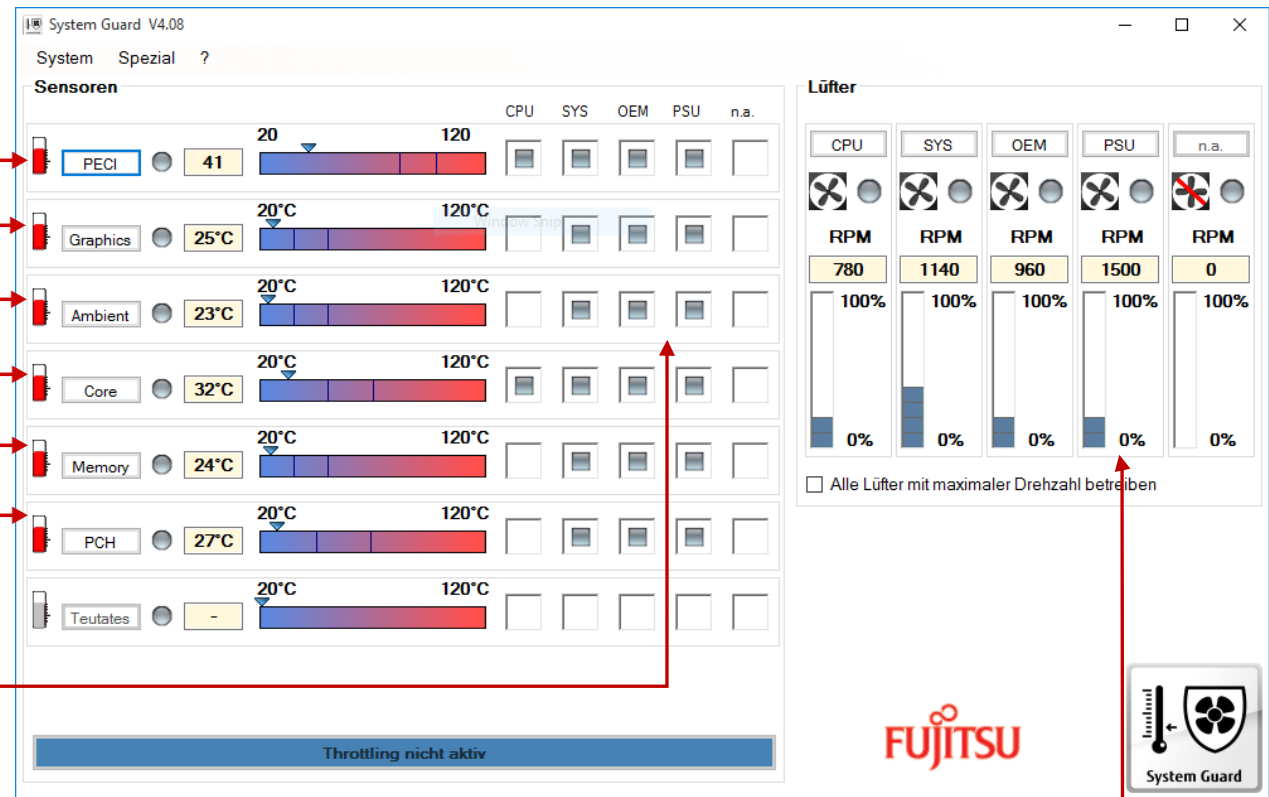

Sensor / Fan Matrix

→ Indicates which sensor influences the specific fan speed
 → Note: Characteristics for FAN-CPU is always dependent on the CPU temperature - fully controlled by the system BIOS.
 Due to safety reasons the influence of the CPU sensor for FAN-CPU cannot be disabled!

PS

→ Displays the fan speed of the optional power supply fan (specific PSU option)

(Note: Sample screenshot only; data may differ for specific mainboard model)

1) Note: The temperature value shown for the processor (digital „PECI“ measurement =Platform Environment Control Interface) does NOT provide the absolute processor temperature. This is a calculated value based on the relative PEGI data.

System Monitoring

4.4 SilentFanConfig-Manager – Customize System Monitoring Settings (Optional)

Windows-based System Management Configuration Tool

ftp://ftp.ts.fujitsu.com/pub/Mainboard-OEM-Sales/Products/Mainboards/Industrial&ExtendedLifetime/D3402-B_D3417-B/Industrial_Tools_D3402-B_D3417-B/SilentFanConfig-Manager/

1. This tool is only provided to qualified system integrators
2. Windows-based configuration tool (SilentFanConfig) to create customized system monitoring settings like minimum fan speed and temperature sensor influence. These customized settings are stored in a specific “SMCO” flash file.
3. DOS-based tool “SMCO” to flash the customized system monitoring settings (SMCO file) to the system BIOS of the target unit.

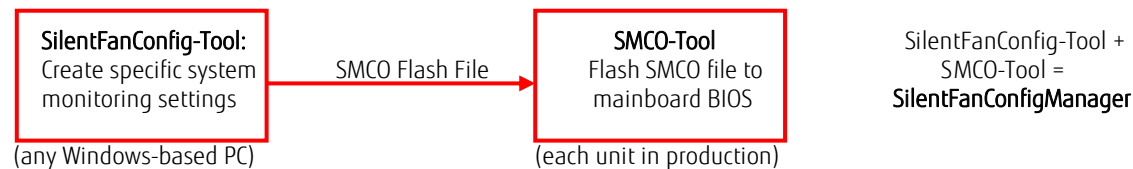

Note: New settings are written permanently to system BIOS.
Any BIOS update will not reset the new settings

SilentFanConfig **V1.81.0** or higher required for D3402-B & D3417-B

Please see documentation in ZIP file (link below) for further details.

ftp://ftp.ts.fujitsu.com/pub/Mainboard-OEM-Sales/Products/Mainboards/Industrial&ExtendedLifetime/D3402-B_D3417-B/Industrial_Tools_D3402-B_D3417-B

System Monitoring

4.5 Components for continuous 24/7 operation @ +50°C

Operating Conditions:
 Circulating air
 (mainboard) max. 50°C
 Usage 24h / 7 days

All onboard electrolyte capacitors: Polymer type only (= solid electrolyte)

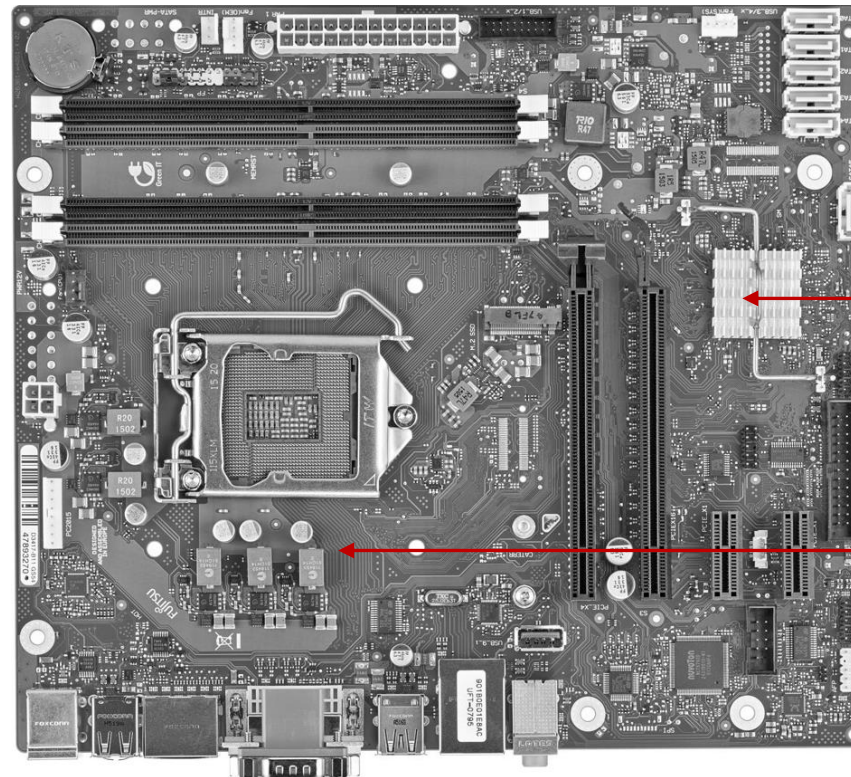

Extra Heatsink on PCH

High Efficiency Processor Core Voltage Regulator for reduced thermal dissipation loss

Note: Power Consumption
 PCH → P max ~ 4.1W
 → P idle ~ 0.7W

Capacitor Endurance Time

Solid Electrolyte: $L_x = L_o * 10^{\left(\frac{t_o - t_x}{20}\right)}$

Fluid Electrolyte: $L_x = L_o * 2^{\left(\frac{t_o - t_x}{10}\right)}$

Lx = effective endurance time
 Lo = endurance time @ 105°C (e.g. 2.000hrs)
 to = 105°C
 tx = capacitor surface temperature (e.g. 75°C)

System Monitoring

4.6 Capacitor Endurance Time Comparison

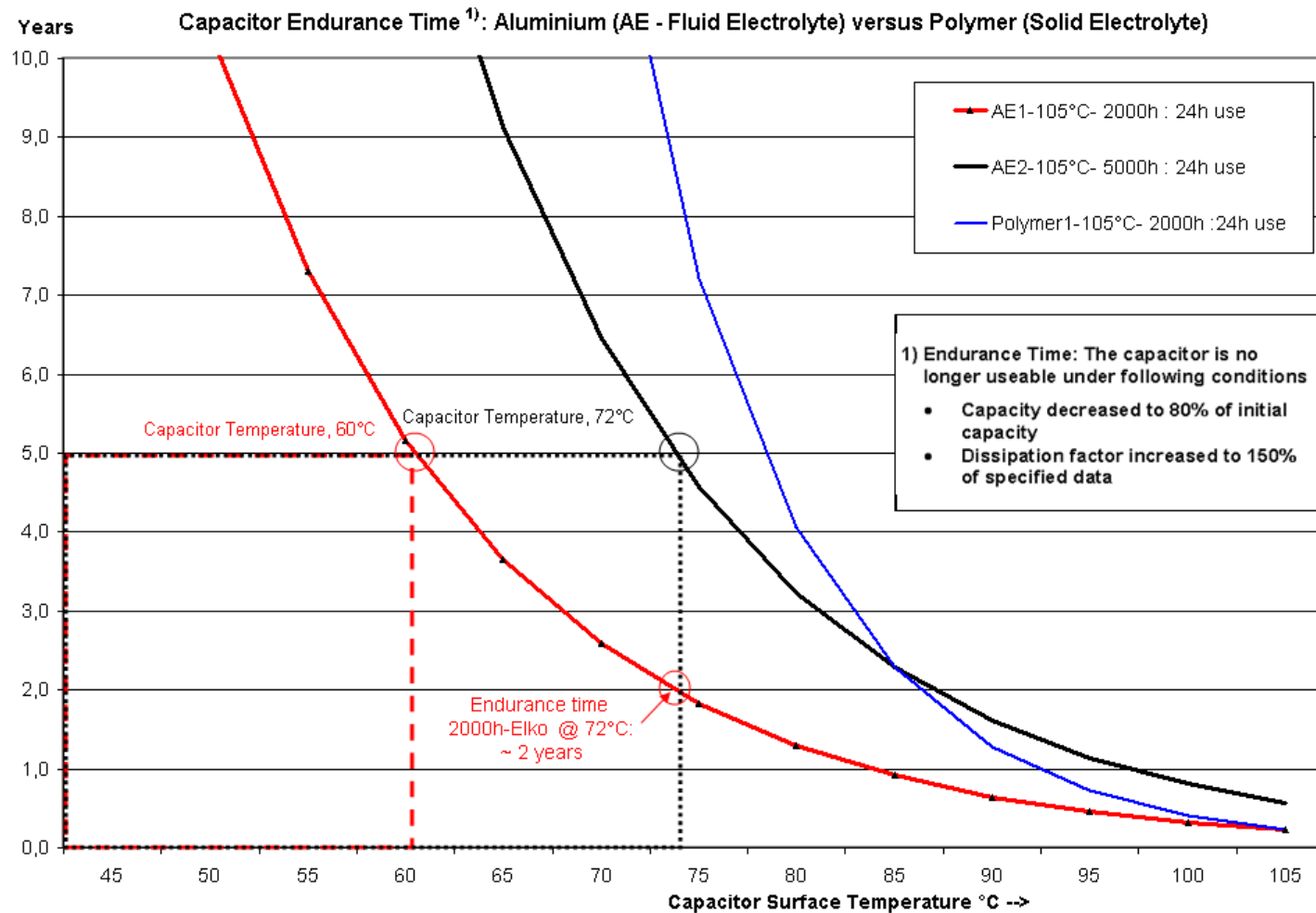

System Monitoring

4.7 Temperature Reference Points D3402-B & D3417-B

Operating Conditions:
 Circulating air
 (mainboard) max. 50°C
 Usage 24h / 7 days

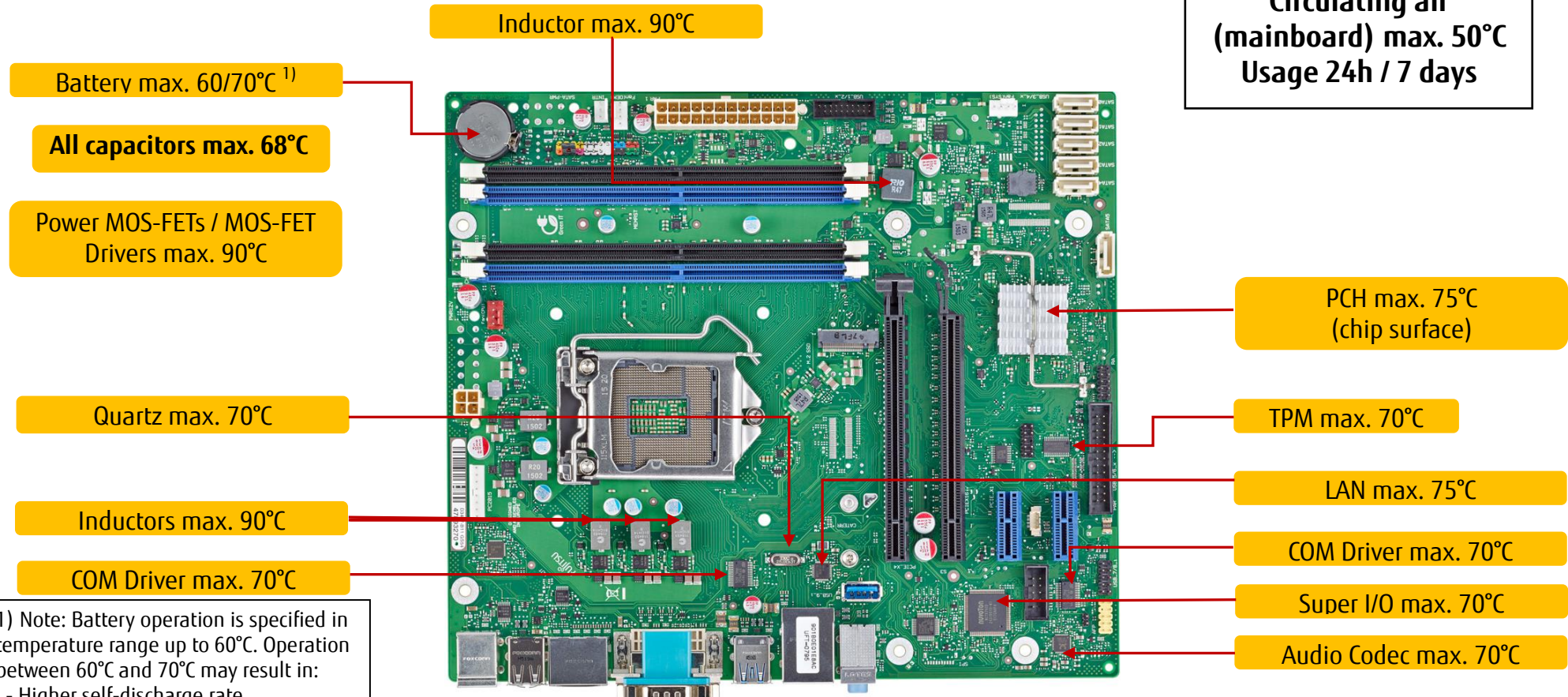

1) Note: Battery operation is specified in temperature range up to 60°C. Operation between 60°C and 70°C may result in:

- Higher self-discharge rate
- Decline of specified characteristics
- Danger of leakage increases

Reference Point Limit Temperatures (Component Surface) must not be exceeded!

System Monitoring

4.8 BMC – BIOS Default Settings D3402-B & D3417-B

The default system monitoring settings like fan speed, sensor influence, and Alert temperatures are fixed by the system BIOS. All relevant settings can be customized by qualified system builders via the optional SilentFanConfig-Manager tool kit.

Sensors →	PECI (Processor)	PCIe Graphics	Ambient	Core regulator	Memory	PCH
Fan (CPU)	X			X		
Fan (SYS)	X	X	X	X	X	X
Fan (OEM)	X	X	X	X	X	X
Fan PSU	X	X	X	X	X	X

"X" indicates that this specific sensor influences the speed of this specific fan

	StartUp ¹⁾	FullSpeed ²⁾	Alert ³⁾	Note
PECI (Processor)	See Note	See Note	See Note	These settings are fixed by the BIOS (depends on the individual installed processor) and cannot be changed via SilentFanConfig-Manager.
PCIe Graphics	35°C	50°C	52°C	These settings are implemented for the current BIOS version and may be changed for upcoming BIOS versions! Default minimum fan speed = 30% (all fans).
Ambient	35°C	50°C	52°C	
Core Regulator	50°C	70°C	72°C	
Memory	35°C	50°C	52°C	
PCH	45°C	70°C	72°C	

- 1) If the sensor temperature is below "StartUp" the fan rotates at its defined minimum fan speed
- 2) Between "StartUp" and "FullSpeed" the fan speed increases linear
- 3) If the sensor temperature reaches "Alert", the system can provide a warning (e.g. via SystemGuard tool)

5 Power Supply

5.1 ATX Power Supply

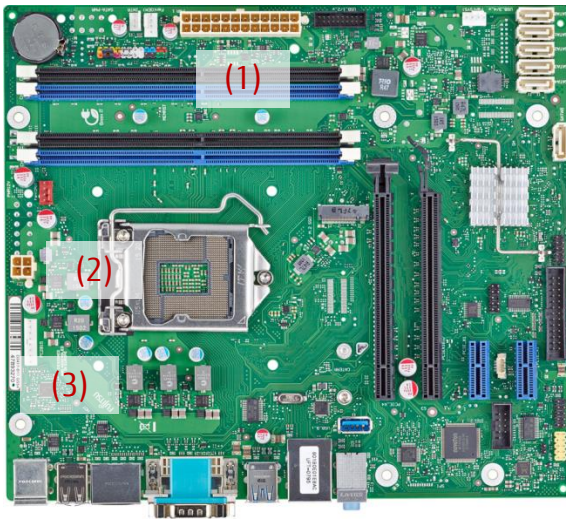

Connectors for ATX (Multirail) Power Supply

- (1) 24 pin connector (ATX layout)
- (2) 4 pin connector (+12V, GND)

Note: The +12V supply (up to 12A) for processor and chipset is provided via the 4 pin connector! Onboard voltage regulators convert the +12V input power to the appropriate processor / chipset supply voltages.

- (3) Processor Core Voltage Regulator: High Efficiency design for enhanced power saving and less thermal dissipation loss.

Requirements for ATX Power Supply

for onboard components (worst case incl. largest processor & memory; w/o USB devices; w/o PCIe cards, w/o M.2 / SATA drives)

Source	Voltage	Min. PS Load	Max. Voltage Tolerance	Mainboard Capacitive Load	Max. Mainboard Current
Main Power Supply	+ 12V	0.05A	± 5 %	5.000µF	10A/15A ¹⁾
	- 12V	0A	± 10 %	470µF	0.3A
	+ 5V	0.2A	± 5 %	3.000µF	6.0A
	+ 3.3V	0A	± 5 %	3.000µF	0.5A
Aux. Power	+ 5Vaux	0A	+5 % / -3%	3.000µF	2.5A

1) D3417-B: Max. Cont. Current = 10A; max. Surge Current (TurboBoost) = 12A (<100sec) / 15A (<10ms)
 D3402-B: Max. Cont. Current = 8A; max. Surge Current (TurboBoost) = 10A (<100sec) / 12A (<10ms)



The ATX power supply must support the minimum load conditions as mentioned in the left chart.

Power Supply

5.2 Typical Power Consumption

Configuration:

D3402-B or D3417-B / Windows 10-64,
 Multirail PSU "gold rating"
 HDD 3.5" SATA; USB Kbd; USB mouse
 Processor/memory see below

Configuration	Application	PSU Input Load	12V for PSU (4 pin connector)	12V System (ATX Connector)	5V System (ATX Connector)	3.3V System (ATX Connector)	5V _{aux} (ATX Connector)
CPU 35W TDP 1 x 4GB	Win10 Idle	15W	0.2A	< 0.2A	0.5A	< 0.3A	< 0.3A
	100% CPU Load	55W	3.5A		1.0A		
	FTS MemTest	35W	1.5A		1.5A		
CPU 65W TDP 1 x 4GB	Win10 Idle	15W	0.3A	< 0.3A	1.0A	< 0.3A	< 0.3A
	100% CPU Load	65W	4.5A		1.1A		
	FTS MemTest	40W	2.0A		1.6A		
CPU 65W TDP 4 x 8GB	Win10 Idle	15W	0.3A	< 0.3A	1.0A	< 0.3A	< 0.3A
	100% CPU Load	65W	4.5A		1.4A		
	FTS MemTest	45W	2.0A		2.0A		
CPU 80W TDP ¹⁾ 1 x 4GB	Win10 Idle	15W	0.3A	< 0.5A	1.0A	< 0.3A	< 0.3A
	100% CPU Load	120W	8.7A		1.2A		
	FTS MemTest	40W	2.4A		1.7A		

Note: 1) only possible with D3417-B

Note: All data = indicative values only (measured with a clamp-on ampere meter)

6 USB Implementation

6.1 USB Ports & USB Power Fuses

D3402/D3417: The chipset only provides one USB controller (xHCI) for all USB ports

Description	USB Port #	Common Fuse	Max. Current per Port	Note
USB 3.0 Frontpanel	#2 / #3	2A	900mA	
USB 2.0 Frontpanel	#8 / #9	2A	500mA	for internal devices ²⁾
USB 2.0 internal	#12 / #13			
USB 3.0 Rear (USB/USB/LAN)	#0 / #1	2A	900mA	
USB 3.0 Rear (USB/USB)	#4 / #5	2A	900mA	
USB 2.0 Rear	#6 / #7	2A	500mA	
USB 3.0 Stick Socket ²⁾	#11	(not fused) ¹⁾	900mA	for internal devices ²⁾

- 1) The internal USB 3.0 stick socket must NOT be used for external connectors as the power line is not fuse-protected!
- 2) Note: These "internal" ports do not provide "Windows Device Eject"

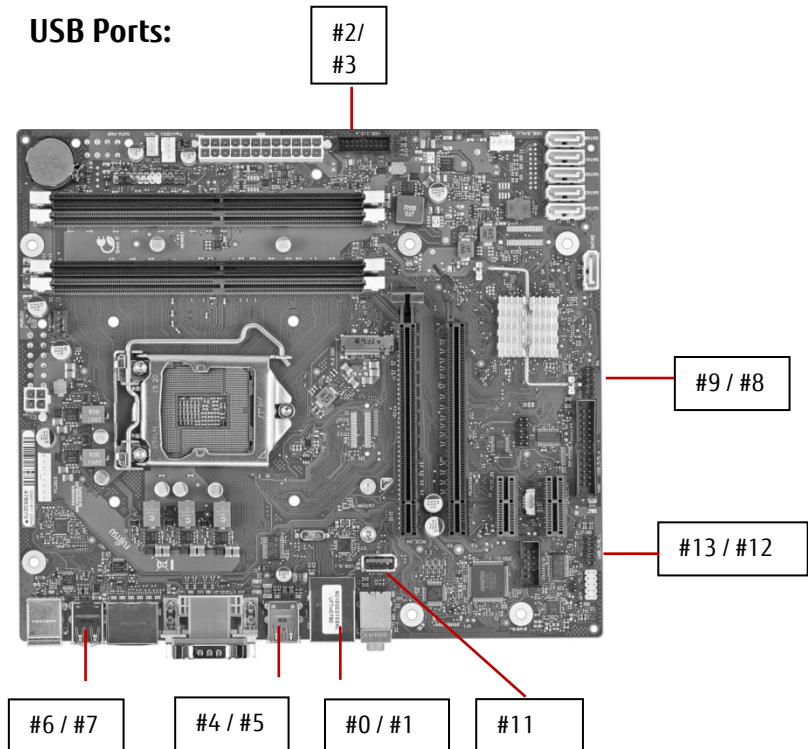

USB Implementation

Rear USB Ports for D3402-B/D3417-B:

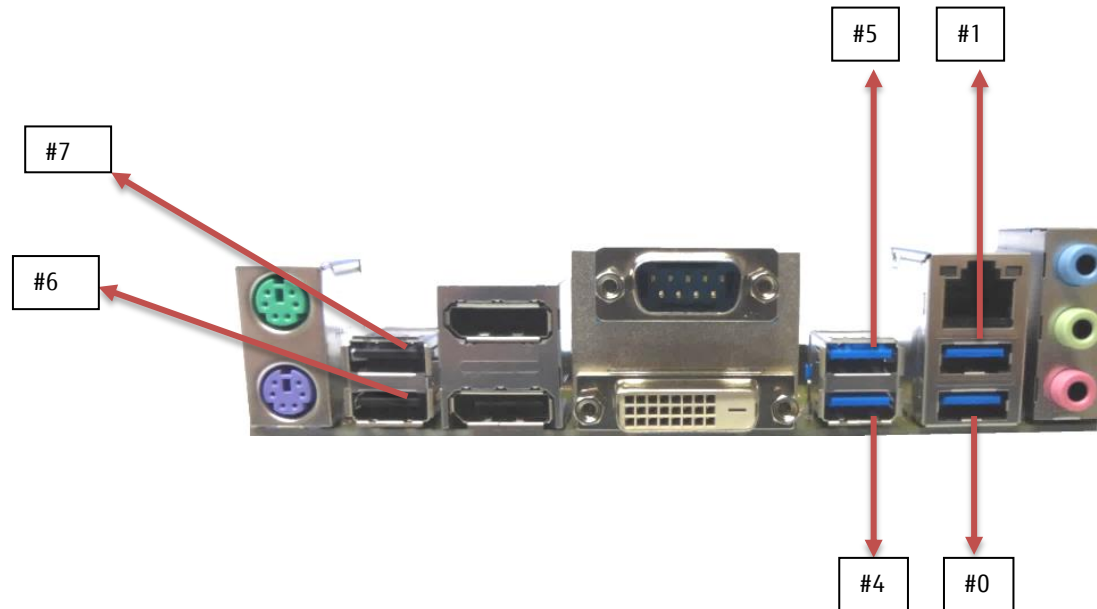

7 Display Options

7.1 Summary: Video Output Options D3402-B & D3417-B

- Up to three independent displays supported
- Supports Clone Mode, Extended Desktop and Collage Mode (combine 2 or 3 displays to one screen)
- Support of 4K display technology via DisplayPort output
- VGA output possible via optional adaptor D3453 (internal DisplayPort to VGA converter)
- If D3453 is installed, in total any three video ports can be used.
- DisplayPort is compatible with following adapters: (Dual Mode / DisplayPort++)
 - > *DP to HDMI* (passive + active) -> *DP to DVI* (passive + active) -> *DP to VGA* (active)
- DVI-D is compatible with *DVI to HDMI* – adapter (passive + active) and *DVI to VGA* – adapter (active)
- The following **active** DVI to VGA – adapters are approved:
 - > Lindy DVI-Adapter - DVI-D (W) - HD-15 (M)
 - > Camac DVI-D 24 + 1
 - > Sienoc DVI-D auf VGA Video Adapter/ Konverter

Display Options

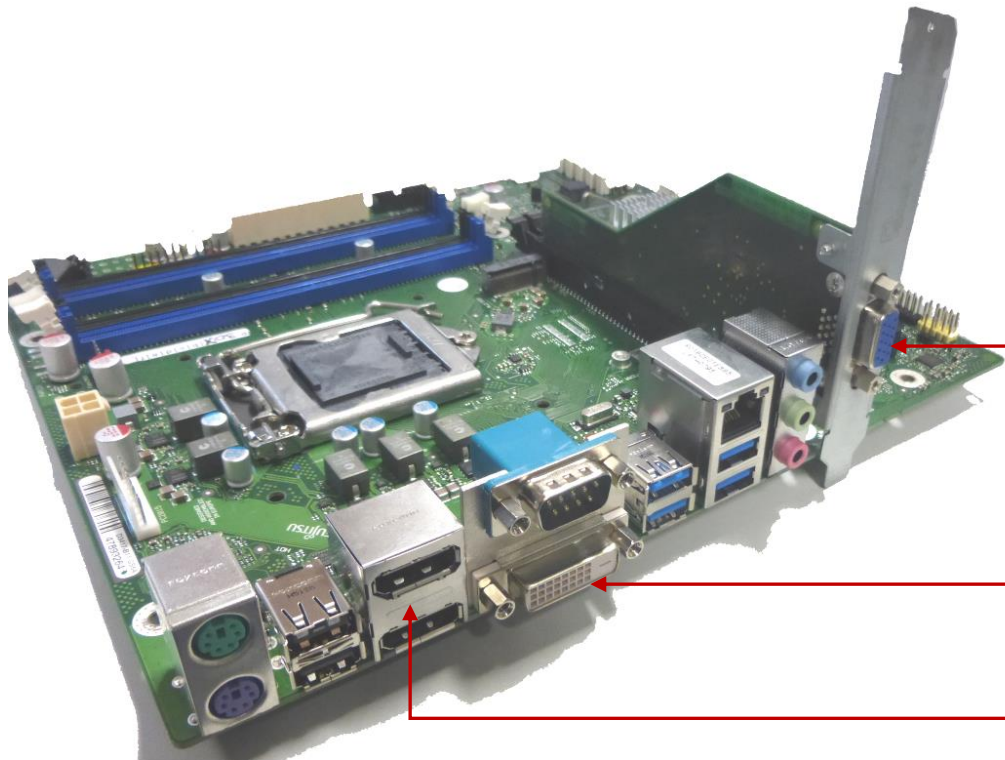

VGA out via optional adapter D3453
Must be plugged in the first PCIe x16 Slot
(4 lanes)

VGA Max. resolutions:
1920 x 1440 @ 60 Hz (18 bpp) -> **recommended**
2048 x 1152 @ 60 Hz (reduced blanking, 24 bpp)
2048 x 1536 @ 50 Hz (reduced blanking, 24 bpp)

DVI-D

DVI-D: max. 1920 x 1200 @ 60Hz

2x DisplayPort

DP: max. 4096 X 2304 @ 60 Hz

8 Operating System Support

- Windows® 7
- Windows® 8.1
- Windows® 10
- Linux

Operating System Support

8.1 Support for Windows 7 / Windows 8.1 / Windows 10 **[Updated]**

- Mainboards D3402-B & D3417-B are designed according to the Microsoft Guidelines for Windows 7, Windows 8.1 and Windows 10
- MS certified drivers are available via OEM DU-DVD and OEM FTP Server



ftp://ftp.ts.fujitsu.com/pub/Mainboard-OEM-Sales/Products/Mainboards/Industrial&ExtendedLifetime/D3402-B_D3417-B/Drivers_D3402_D3417/

OS	"Runnable"	"Tested/Released by Fujitsu"
MS Windows XP	--	--
MS Windows 7-32 ¹⁾	X	X
MS Windows 7-64 ¹⁾	X	X
MS Windows 8.1-64 ¹⁾	X	--
MS Windows 10-64	X	X
Linux-32	X	--
Linux-64	X	--

1) Requires Skylake processor!

Operating System Support

8.2 Linux Support

For the Skylake CPU and Chipset a vanilla kernel version of 4.3.0 or newer is required.

The following distributions have been tested:

Fedora 23 works fine on Skylake.

OpenSUSE Leap 42.1 still has some graphic issues with the Skylake platform. You either upgrade your kernel or you take OpenSUSE Tumbleweed which is a "rolling release".

Red Hat Enterprise Linux (RHEL) introduced Skylake support in these version:

- RHEL 6.7 (for the RHEL 6 mainline)
- RHEL 7.2 (for the RHEL 7 mainline)

Note: Both versions still lack the latest DRM graphics patches , so there will be a black screen after suspend.

SUSE Linux Enterprise (SLE) introduced Skylake support in these version:

- SLE 11 SP4 (for the SLE 11 mainline)
- SLE 12 SP1 (For the SLE 12 mainline)

Note: in both cases the suspend function does not work and screen remains black after wakeup.

Ubuntu 14.04.4 (the latest update, released in March 2016) fully supports Skylake.

Ubuntu 15.10 might run into some problems.

Debian 8.x ("Jessie") comes with a 3.16 kernel out of the box and so it will run into troubles.

Note: On Debian-backports there is a 4.3.0 kernel available for Jessie that would solve those issues.



9 Mainboard Tools

Common Mainboard Tools



Note: Make sure not to use any DOS memory managers like *himem.sys* or *emm386!*

9.1 BIOS Boot Logo Tool (This tool is only provided to qualified system integrators)

Tool to integrate a customized boot logo

ftp://ftp.ts.fujitsu.com/pub/Mainboard-OEM-Sales/Services/Software&Tools/Common-Mainboard-Tools/BootLogo_4_UEFI/

9.2 EditCMOS (This tool is only provided to qualified system integrators)

DOS-based production tool to change BIOS settings
and freeze customized BIOS settings (= customized default settings)

ftp://ftp.ts.fujitsu.com/pub/Mainboard-OEM-Sales/Services/Software&Tools/Common-Mainboard-Tools/EditCMOS_UEFI/

9.3 OEMIDENT (This tool is only provided to qualified system integrators)

Production tool to add MS OEM license data (SLP1 / SLP2.x / OA3.0)
Add an individual customer serial no / add a chassis asset tag and patch several DMI data
Disable and hide TPM feature in BIOS Setup

<ftp://ftp.ts.fujitsu.com/pub/Mainboard-OEM-Sales/Services/Software&Tools/Common-Mainboard-Tools/OEM-Ident/>

Mainboard Tools

9.4 SystemGuard

Windows-based tool to monitor temperatures and fan speed of FTS mainboards
 Option to configure automatic fan ageing supervision
 Provides access to the System Watchdog

<ftp://ftp.ts.fujitsu.com/pub/Mainboard-OEM-Sales/Services/Software&Tools/Common-Mainboard-Tools/SystemGuard/>

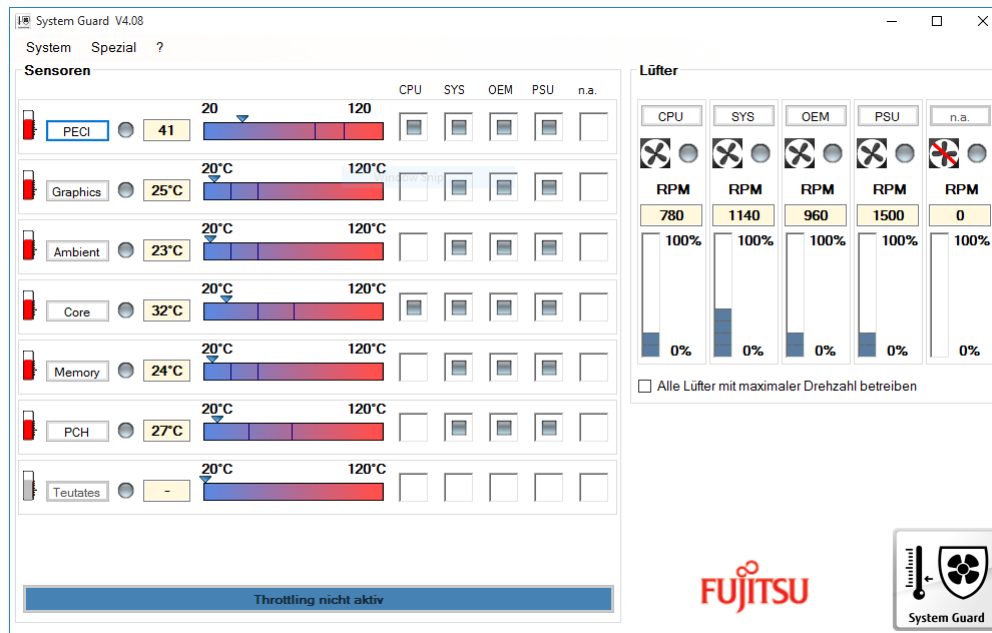

Note: SystemGuard V4.08 (or higher) required for D3402-B / D3417-B

Mainboard Tools

Industrial Tools



9.5 SilentFanConfig-Manager (This tool is only provided to qualified system integrators)

Windows-based configuration tool to implement customized fan characteristics and temperature parameters. Includes DOS-based tool "SMCO" to flash the configuration file permanently into the system BIOS.

ftp://ftp.ts.fujitsu.com/pub/Mainboard-OEM-Sales/Products/Mainboards/Industrial&ExtendedLifetime/D3402-B_D3417-B/Industrial_Tools/

9.6 Windows System-Monitoring API (BMC-API - This tool is only provided to qualified system integrators)

BMC-Management-Controller to access and adjust System Monitoring parameters like fan speed and temperatures. This API also provides access to the mainboard watchdog, and the intrusion feature of the mainboard.

ftp://ftp.ts.fujitsu.com/pub/Mainboard-OEM-Sales/Products/Mainboards/Industrial&ExtendedLifetime/D3402-B_D3417-B/Industrial_Tools/

9.7 Linux System-Monitoring Driver ("LM-Sensors")

BMC-Management-Controller to access and adjust System Monitoring parameters like fan speed and temperatures. This driver also provides access to the mainboard watchdog.

ftp://ftp.ts.fujitsu.com/pub/Mainboard-OEM-Sales/Products/Mainboards/Industrial&ExtendedLifetime/D344x-S/IndustrialTools_D344x-S/Linux_SystemMonitoring&Watchdog&GPIO/

10 Known Issues & Important Notes

10.1 USB 2.0 – USB 3.0 / MS Windows 7

Windows 7 does not natively support the Skylake USB controller --> PS/2 keyboard/mouse for OS setup recommended
 Current BIOS versions include a workaround (USB/PS2 emulation) in order to use USB keyboard / mouse during MS Windows 7 installation.
 This emulation should be disabled after Windows 7 is installed and the appropriate USB driver has been implemented. For Windows 7 installation a SATA DVD drive has to be used or the XHCI driver has to be integrated into the installation files to be able to use any USB drive during installation.

Note:
 Intel removed the EHCI USB controller, which is replaced by the xHCI USB controller.
 MS Windows 7 only provides inbox driver support for EHCI;
 the xHCI USB device driver must be installed first before any USB port can be used when running MS Windows 7.

10.2 TPM2.0 / MS Windows

All Fujitsu Skylake-based mainboards provide TPM V2.0. as recommended for MS Windows 10.

	Win7 (x32/x64) legacy	Win7 (x32) UEFI	Win7 (x64) UEFI	Win8.x (x32/x64) Legacy	Win8.x (x32/x64) UEFI	Win10 (x32/x64) Legacy	Win10 (x32/x64) UEFI
TPM 2.0 Support	No	No	YES ¹⁾	No	YES	No	YES

1) MS Hotfix required: Update to add support for TPM 2.0 in Windows 7 and Windows Server 2008: <https://support.microsoft.com/en-us/kb/2920188>

As TPM 2.0 is not supported by MS Windows 7 (except for 64Bit/UEFI), TPM should be disabled in BIOS Setup in this case

10.3 Parallel Port – Intel Limitation

Due to chipset limitations Skylake-based mainboards no longer support EPC DMA mode for the parallel port.

11 Miscellaneous

11.1 Battery Lifetime

The typical battery lifetime is designed for 5 years.

This is based on following usage profile:

- G3 → 28% / two days per week
(System Off, Power disconnected)
- Deep S5/S4/S3 → 48% / 17 hours per working day
(System Off, Power connected)
- S0 → 24% / 8 hours per working day
(System Working)

On-Temperature (S0): 70°C

Off-Temperature (G3, S5/S4/S3): 23°C

Note: If the system is never in G3 mode or if the S0 “working” temperature is lower than 70°C, this may result in much higher battery lifetime.

If the mainboard is just stored (no operating voltage attached), the typical battery lifetime is also 5 years. Due to tolerances of the installed battery, the effective battery lifetime may be in the range of 4.5 years – 6 years

Miscellaneous

11.2 RealTime Clock (RTC) Accuracy

The onboard realtime clock is approved for an accuracy of $\pm 30\text{ppm}$ (= max. 75sec deviation per month).

The RTC crystal itself is specified with $\pm 10\text{ppm}$ (= max. 26 seconds deviation per month).
Each year of ageing adds around $\pm 3\text{ppm}$ on top of this.

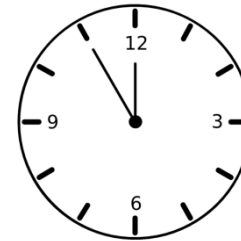

Miscellaneous

11.3 System Watchdog (WD)

Mainboards provide full BIOS POST-, Operating System Boot-, and Operating System-Runtime watchdog supervision.

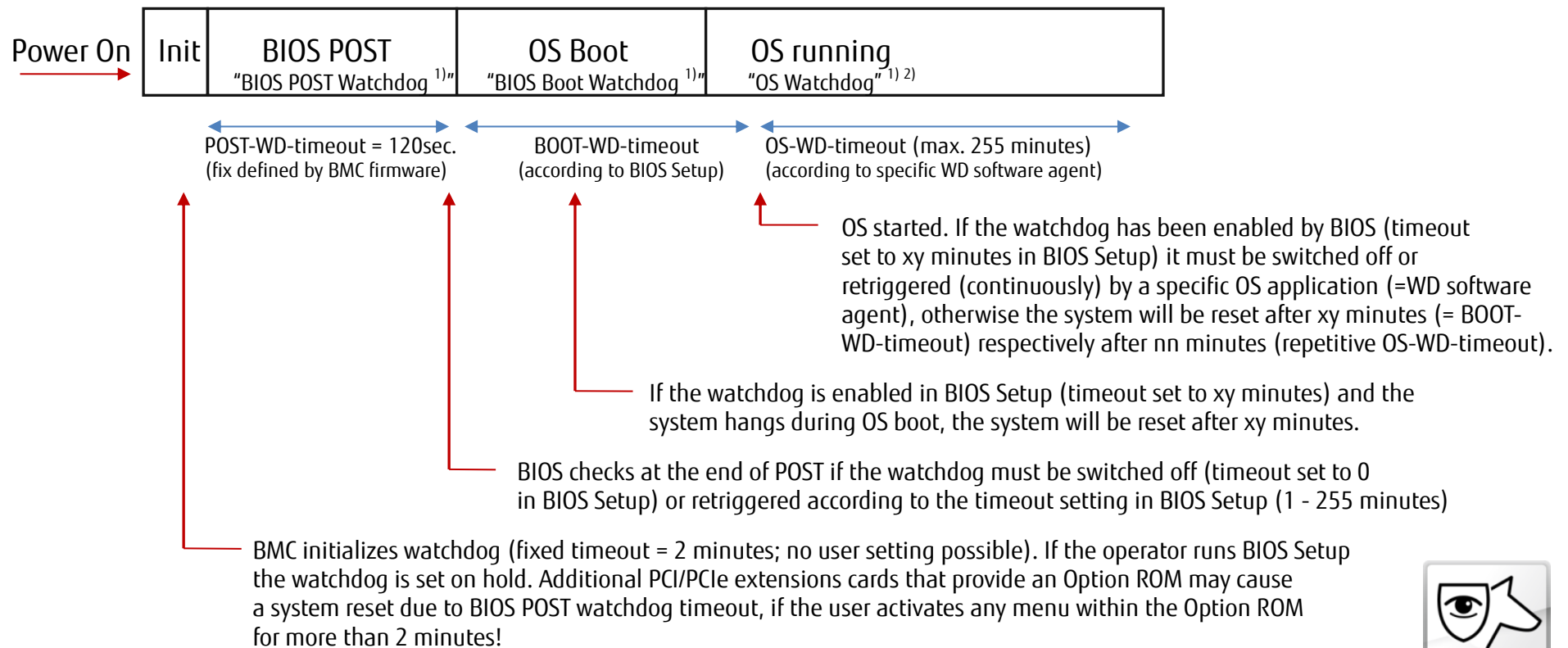

1) Note: All three watchdogs are physical identical, but they are handled from different application levels
 2) As the SystemGuard tool offers access to the watchdog, it can be used as "WD software agent" to retrigger the watchdog during OS runtime

Miscellaneous

System Watchdog (WD)

How to handle the different watchdog levels

- **BIOS POST Watchdog**

- No user interaction possible – POST Watchdog is always enabled!

- **BIOS Boot Watchdog**

- Set Watchdog in BIOS Setup

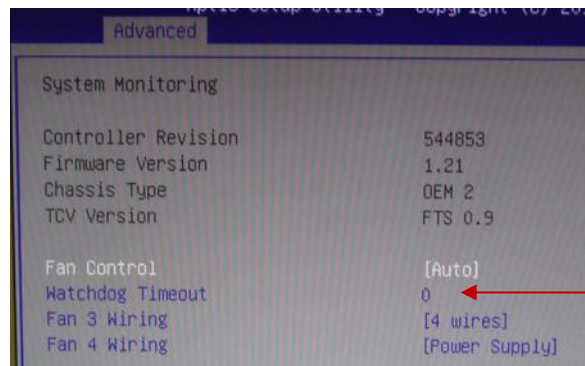

0 = WD disabled
 1 – 255 = WD enabled (timeout = 1 – 255 minutes)

Miscellaneous

System Watchdog (WD)

OS Watchdog

Use "WD software agent" to stop or retrigger the watchdog during OS runtime

Note: This "agent" needs to be provided by the customer, dependent on his needs. For easy access to the watchdog functions, the optional Windows API (BMC API - This tool is only provided to qualified system integrators) or the related Linux driver (lm-sensors) can be used:

http://ftp.ts.fujitsu.com/pub/Mainboard-OEM-Sales/Products/Mainboards/Industrial&ExtendedLifetime/D3402-B D3417-B/Industrial_Tools/

- For easy testing, the SystemGuard tool provides access to the OS Watchdog. After enabling the Watchdog, SystemGuard retriggers the WD continuously. In case the system freezes, SystemGuard does no longer provide the retrigger signal and the watchdog resets the system after the timeout.
Note: When SystemGuard is closed, the WD is stopped in order to avoid a unwanted system reset!

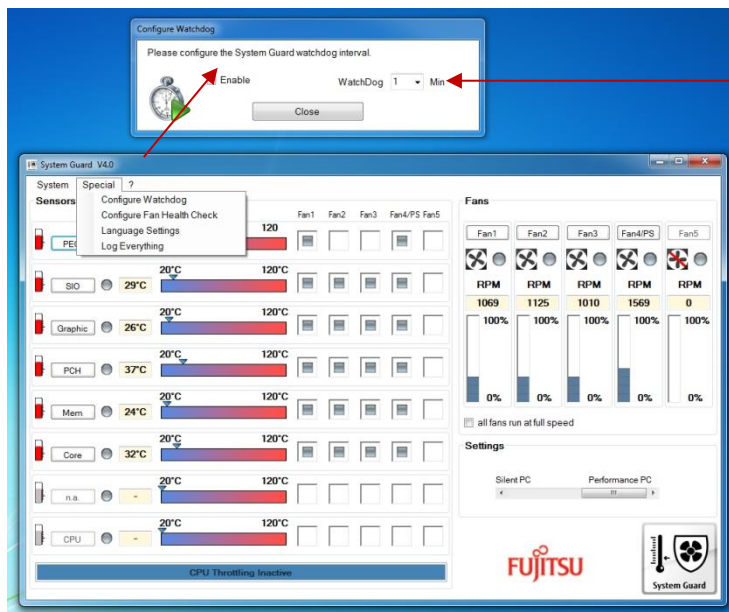

Menu "Special":
--> Enable WD
--> Set timeout to 1 - 8 minutes

Miscellaneous

11.4 BIOS Update / BIOS Recovery

BIOS update options

Link to related BIOS files (OEM FTP Server):

ftp://ftp.ts.fujitsu.com/pub/Mainboard-OEM-Sales/Products/Mainboards/Industrial&ExtendedLifetime/D3402-B_D3417-B/BIOS/

DOS-based BIOS update (DOS-bootable USB stick)

Required BIOS files:

- EfiFlash.exe (DOS flash tool)
- DosFlash.bat (batch file)
- Dxxx-y.upd (flash file)

Copy unzipped files to a DOS-bootable USB stick, boot system from stick and run *DosFlash.bat*

Note: In order to easily create a Free-DOS bootable stick, the Fujitsu *BootStick* tool can be used:

<ftp://ftp.ts.fujitsu.com/pub/Mainboard-OEM-Sales/Services/Software&Tools/Common-Mainboard-Tools/USB-FreeDOS-Bootstick/>

Note: Make sure not to use any DOS memory managers like *himem.sys* or *emm386!*

Miscellaneous

BIOS Update / BIOS Recovery

. Windows-based BIOS update (Deskflash tool)

Required BIOS file:

- Dxxxx-Sx.R1.x.y.**DFI.exe** (Windows executable flash tool)

Copy file from FTP (link see above), rename *filename.\$xe* to *filename.exe* and copy to target system (e.g. Windows desktop).
 Doubleclick to start BIOS update and follow instructions on the screen.

. DOS-based BIOS Recovery (DOS-bootable USB stick)

Required BIOS files:

- EfiFlash.exe (DOS flash tool)
- DosFlash.bat (batch file)
- Dxxxx-S1.upd (flash file)
- Dxxxx-S1.rom --> **Important: These files must be located in the root directory of the USB stick!**

Copy the *.ROM file (included in the ZIP file) to the root directory of a FAT32 formatted bootable USB stick.
 Power off the mainboard, insert the USB stick, set the jumper to Recovery Mode (see picture), then turn on the mainboard.

You will hear short beeps while the BIOS is recovered. Wait until you hear a series of "long-long-short-short" beeps. Then turn off the mainboard and move the jumper back to the standard position.

The Recovery process can take a few minutes.

Note: BIOS Recovery should only be used to repair a corrupted BIOS.

All customized data except for OEM SLP data will be reset.

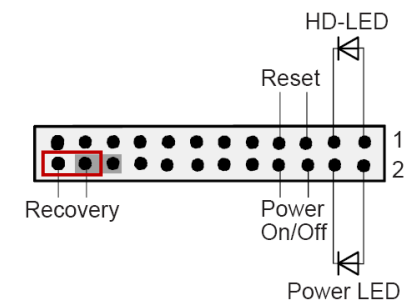

Miscellaneous

11.5 BIOS integrated HW Diagnostic Tool

There is a hardware test module integrated in the system BIOS.
 In order to run the tool, please select "Diagnostic Program" as boot device and follow the instructions on the screen.
 This test module analyzes CPU, Memory and HDD.

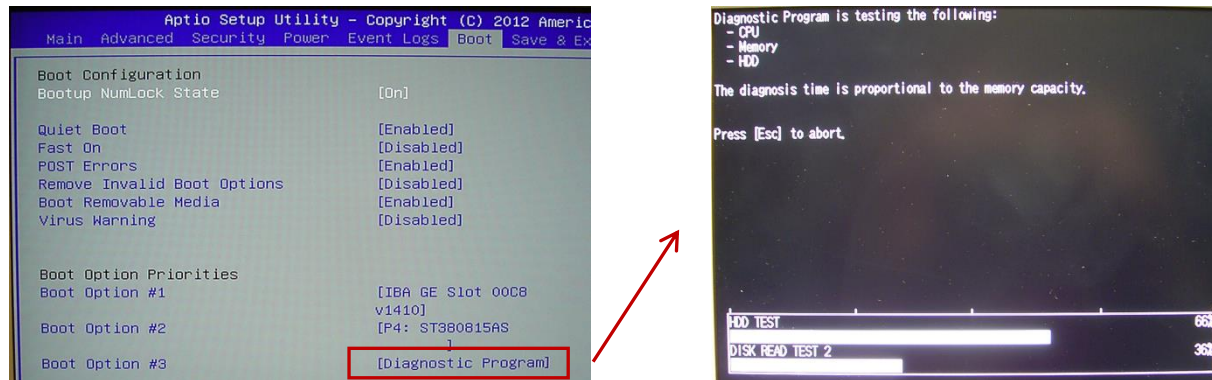

11.6 BIOS integrated Erase Disk Tool (optional)

With the previous mainboard generations Fujitsu introduced the integrated BIOS tool *Erase Disk*, a feature for secure deletion of any data on a harddisk drive.

Please note that this tool can be ordered as an optional feature for D3402-B and D3417-B. For ordering details please see price list.

Detailed information about Erase Disk is available here:

ftp://ftp.ts.fujitsu.com/pub/Mainboard-OEM-Sales/Products/Mainboards/Industrial&ExtendedLifetime/D3402-B_D3417-B/Documentation/PF_EraseDisk_e.pdf

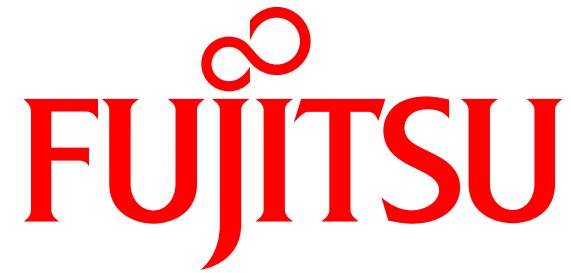

shaping tomorrow with you